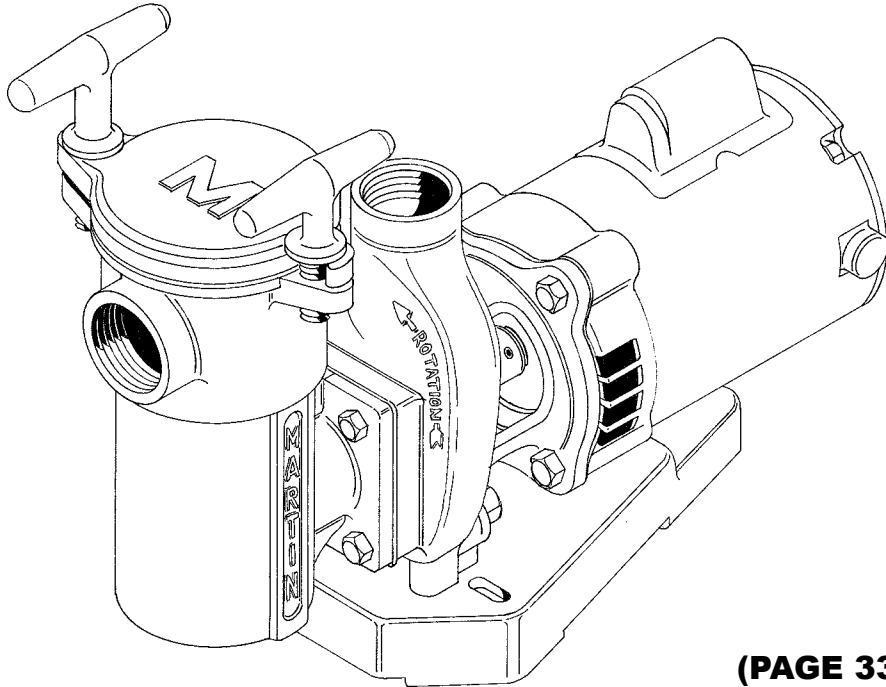

TABLE OF CONTENTS

New Products For 2009	3
The Story Of Val-Pak Products	5
Terms And Conditions Of Sale	6
American Products Pump Parts	7
American Products Skimmer Parts	9
American Products Return Fittings	10
American Products Filter Parts	11
Anthony Pump Parts	13
Anthony 1½ & 2” Selector Valve Exploded View	15
Anthony Backwash Valve Parts	16
Anthony Apollo Filter Exploded View	18
Anthony Filter Parts	19
Anthony Light Parts	22
Anthony Skimmer Parts	23
A.O. Smith Heater Parts	24
Aqua-Flo Pump Parts	26
Dominator Pump Parts	28
Hayward Replacement Baskets	30
Hayward Replacement Parts	31
Landon & Marlin Deck Filter Parts	32
Martin 100 Series 1/3-3 Horsepower Brass Pump	33
Martin 100 Series Brass Pump Exploded View	34
Martin 500 Series 3-10 Horsepower Brass Pump	35
Martin 500 Series Brass Pump Exploded View	36
Pac-Fab Pump Parts	37
Pac-Fab Filter Parts	38
Pool Sweep Parts	41
Premier Pump Parts	42
Premier Filter Parts	46
Purex Pump Parts	47
Purex Backwash Valve Exploded View	49
Purex Backwash Valve Parts	50
Purex Ortega Valve Parts	52
Purex Return Fittings	53
Purex Filter Parts.....	54
Purex Center Rods	56
Sta-Rite Pump Parts	58
Sta-Rite Filter Parts	62
Swimquip Pump Parts	64
Swimquip Filter Parts	65
Swimrite Equipment Parts	66
Miscellaneous Parts & Products	67
Pump & Skimmer Baskets	71
O-Rings	73

NEW PRODUCTS FOR 2009!

MARTIN 100 SERIES 1/3-3 HORSEPOWER BRASS PUMP



(PAGE 33)

MARTIN 500 SERIES 3-10 HORSEPOWER BRASS PUMP

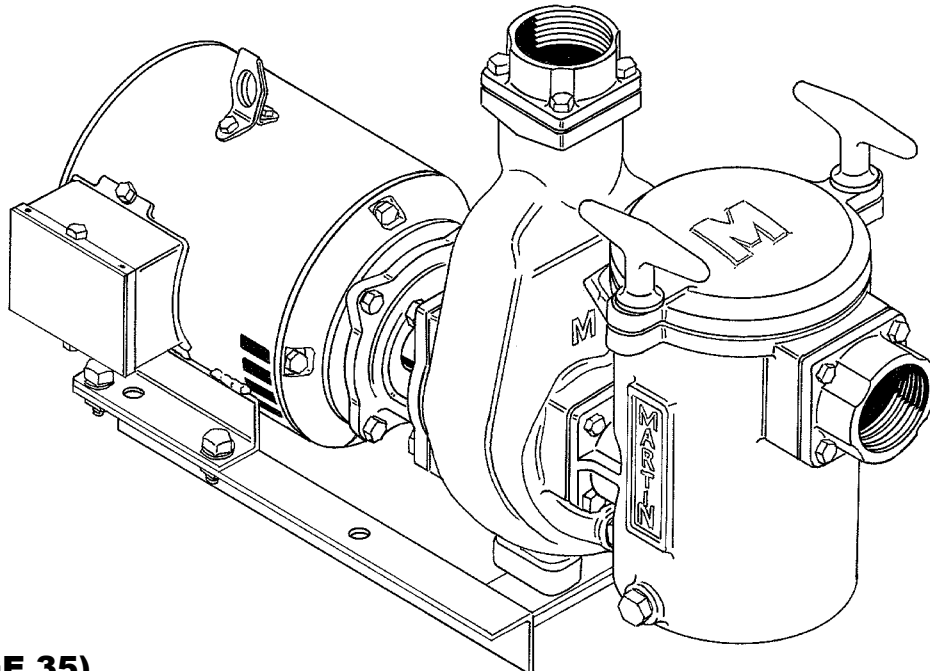

(PAGE 35)

NEW PRODUCTS FOR 2009!

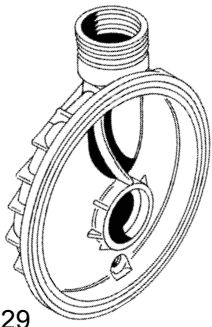

Dominator
Volute
See Page 29

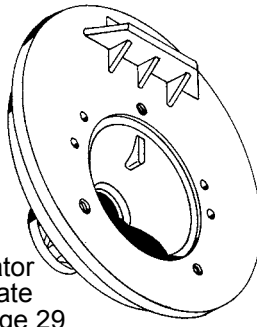

Dominator
Seal Plate
See Page 29

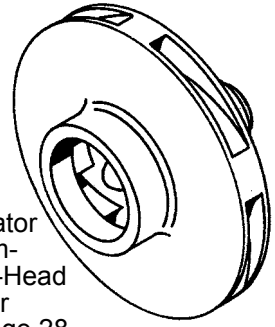

Dominator
Medium-
& High-Head
Impeller
See Page 28

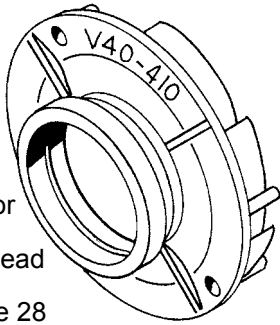

Dominator
Medium-
& High-Head
Diffuser
See Page 28

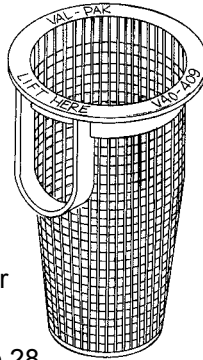

Dominator
Pump
Basket
See Page 28

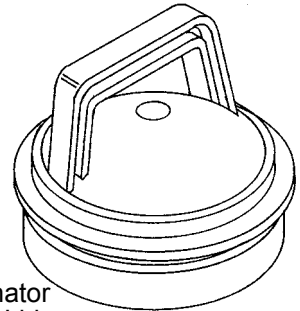

Dominator
Pump Lid
See Page 28

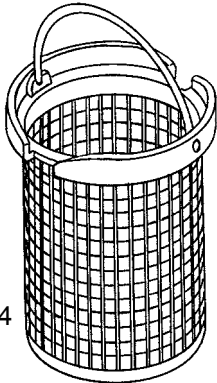

Martin
5\"/>

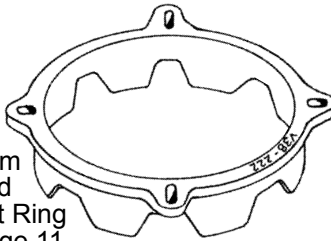

Quantum
Manifold
Support Ring
See Page 11

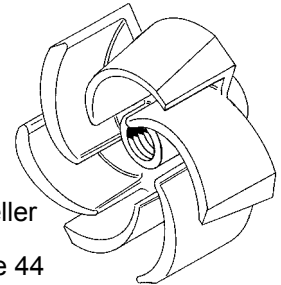

Premier
658 Impeller
3-10 hp
See Page 44

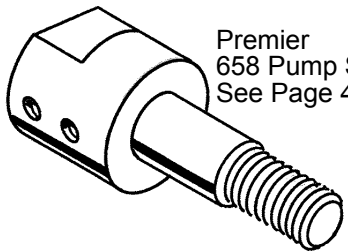

Premier
658 Pump Shaft
See Page 44

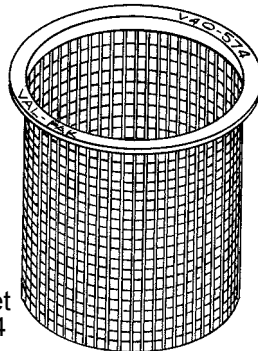

Premier
658
8\"/>

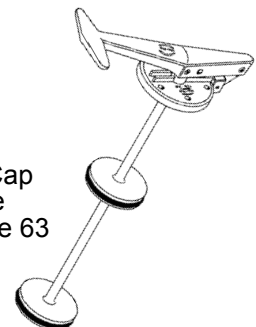

Sta-Rite
Duetta
Piston, Cap
& Handle
See Page 63

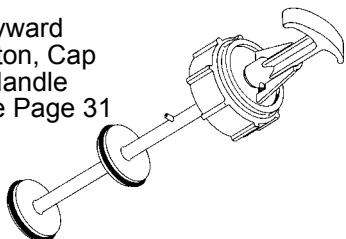

Hayward
Piston, Cap
& Handle
See Page 31

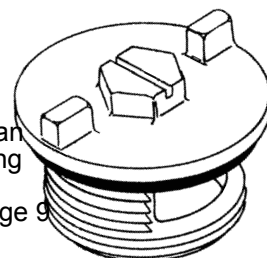

American
Throttling
Plug
See Page 9

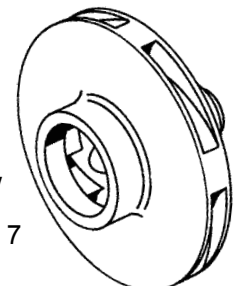

Ultra Flow
Impeller
See Page 7

THE STORY OF VAL-PAK PRODUCTS

Established in 1979, Val-Pak Products was founded by a pool service professional who became frustrated when a large pump manufacturer stopped making a widely used repair part.

Unable to obtain the copper liner he needed to perform pump repairs, Ben Solakian decided to manufacture the part himself. In his garage workshop in Van Nuys, Calif., he started to turn out the liners and sell them through a local wholesale distributor. A cast-iron adapter for the same line of pumps was added shortly thereafter as the original manufacturer stopped making them.

The initial demand for Val-Pak's repair parts was overwhelming. As equipment makers discontinued various parts, Val-Pak began producing them. Starting with a single part, the Val-Pak line has grown to include more than 500 repair and replacement products.

In 1984, joined by his son, Mike, Ben Solakian opened a 2,500-square-foot building in Saugus, Calif. Val-Pak continued to expand its parts line and also began packaging private-label chemical products, adding silk-screen bottle-decorating and filling to its list of services.

The company soon outgrew its Saugus plant, and in 1986 relocated to a 6,800-square-foot facility in Valencia, Calif. Just one year later, it expanded to a 10,800-square-foot building in nearby Canyon Country, Calif., where it remained until 2002.

To gain greater control over the quality of its manufacturing operation, Val-Pak in 1990 purchased a state-of-the-art machining center. A pair of computerized lathes and an additional machining center were added as the business expanded throughout the 1990s.

Also in 1990, Val-Pak began to manufacture D.E. filter grids, purchasing the molded grid frames from an outside supplier and sewing on the fabric to produce the finished product. An 1,100-square-foot building was opened specifically for this operation. And in 1993, an additional 1,800-square-foot building was opened to accommodate Val-Pak's silk-screen operation.

To further increase its ability to control every step of the manufacturing process, Val-Pak in 1998 purchased an injection molding company in Chatsworth, Calif., enabling it to mold all of its plastic parts in-house. One year later, it began to build a mold-making shop so it could actually produce the molds from which its plastic parts are made. Currently, Val-Pak has three full-time tool and die makers to run its mold-making operation.

Val-Pak has never stopped growing. In 2002, it moved to its present location — a new 34,000-square-foot facility in Santa Clarita, Calif. — and consolidated all of its operations there. With 20 employees, all of the company's manufacturing, mold making, injection molding and machining is performed in-house, with no outsourcing. This permits the company to react quickly to customer demands and to maintain absolute control over the quality of its products.

In April 2006, Val-Pak purchased the assets of Martin Pump Co., which made 1/3- to 3-horsepower residential brass pumps and 3-, 5-, 7½- and 10-horsepower commercial brass pumps. And on June 1, 2007, Val-Pak acquired the assets of Aqua-Flo, another maker of residential and commercial brass pumps. The acquisitions allow Val-Pak to meet demands of other industries worldwide.

With the vast in-field experience of its owners, Val-Pak is able to keep a watchful eye on market demands and over the quality & durability of its products, which always exceed the specifications of the original manufacturer.

All Val-Pak parts are produced to the highest standards and sold through distribution. The quality and reliability of its products have made Val-Pak the brand that professional pool and spa service and repair technicians ask for by name.

TERMS AND CONDITIONS OF SALE

- • • **PRICES:**

All products and prices are subject to change without notice.

- • • **PAYMENT TERMS:**

All invoices are due and payable as per the terms on the invoice. No further discounts will be allowed.

All invoices are due within 30 days. Any invoices that are not paid will be subject to a late fee of 1.5% per month.

- • • **ORDERING:**

To insure prompt and proper shipment, please order by Val-Pak number and description.

- • • **MINIMUM ORDER:**

\$100

- • • **SHIPPING:**

No Vender Direct Shipping

- • • **FREIGHT DAMAGE:**

Val-Pak is not responsible for merchandise lost, damaged or destroyed after picked up by carrier and consigned to purchaser. If a claim is necessary, Val-Pak will furnish proof of shipment to purchaser, but claims must be filed with carrier.

- • • **RETURNED CHECKS:**

All returned checks are subject to a \$20.00 service charge.

- • • **RETURNED MERCHANDISE:**

All merchandise returned for credit is subject to a 20% restocking charge.

Special-ordered, non-stocked merchandise is not returnable. All returns must be in the original, resaleable cartons. All returns must be submitted within 30 days.

- • • **OUR PRODUCTS:**

Val-Pak products are produced to the highest standards that meet or exceed OEM specifications.

Val-Pak Products does not represent that Val-Pak's parts are either manufactured or endorsed by the original equipment manufacturer.

Any mention of the OEM's product name or part number is for reference purposes only.

- • • **COPYRIGHT:**

No part of this publication may be reproduced, photocopied, stored in a retrieval system, or transmitted in any form or by any means, without prior written permission of Val-Pak Products.

AMERICAN PRODUCTS PUMP PARTS

MARINE PUMP LID, CLAMP, KNOB, T-BOLT

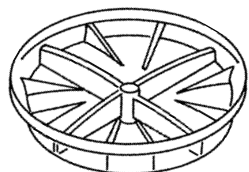

Val-Pak Part No.	Description	OEM Part No.	List Price
V38-112	Marine Pump Clear Lid — 6¾" dia.	393002	\$58.39
V38-113	Marine Pump Clamp — 6¾"	393005	\$68.10
V38-118	Marine Pump Clamp Knob	39302700	\$ 9.00
V38-119	Pump Clamp T-Bolt 1/4 x 20"		\$ 9.78

AMERICANA PUMP IMPELLER

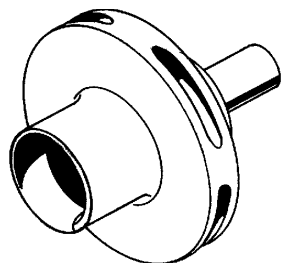

Val-Pak Part No.	Description	OEM Part No.	List Price
V38-180	3/4 Horsepower Impeller	39500700	\$74.85
V38-181	1 Horsepower Impeller	39500800	\$74.85
V38-182	1½ Horsepower Impeller	39500900	\$74.85
V38-183	2 Horsepower Impeller	39501000	\$74.85

ULTRA FLOW IMPELLER, DIFFUSER, WEAR RING



Val-Pak Part No.	Description	OEM Part No.	List Price
V38-122	1/2 Horsepower Impeller	39005610	\$71.85
V38-123	3/4 Horsepower Impeller	39005010	\$64.50
V38-124	1 Horsepower Impeller	39005110	\$64.50
V38-126	1½ Horsepower Impeller	39005210	\$67.50
V38-127	2 Horsepower Impeller	39005310	\$67.50
V38-128	3 Horsepower Impeller	39005410	\$67.50
V38-132	Diffuser, 1/2-1½ HP	39005500	\$17.85
V38-133	Diffuser, 2 & 3 HP	39015500	\$17.85
V38-134	Wear Ring	39006900	\$12.00

ULTRA FLOW PUMP LID, O-RING

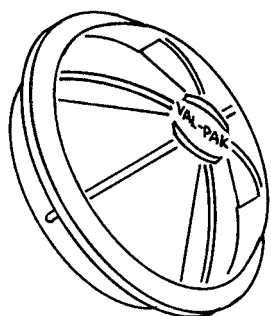

Val-Pak Part No.	Description	OEM Part No.	List Price
V38-160	Ultra-Flow Pump Lid (pre-94) Americana 1 & 2 -7¾" dia.	39301600	\$44.25
V38-161	Ultra-Flow Lid O-Ring (pre-94) Americana 1 & 2 (12/Bag)	39300300	\$ 3.43
V38-162	Ultra-Flow Pump Lid (94-Present)	39301700	\$31.49
V38-164	Ultra-Flow Lid O-Ring (94-Present) (12/Bag)	39300600	\$ 3.43

AMERICAN PRODUCTS PUMP PARTS (Continued)

ULTRA FLOW LID CLAMP, VOLUTE CLAMP

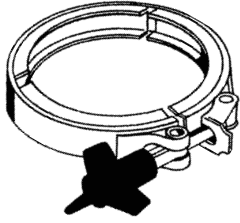

Val-Pak Part No.	Description	OEM Part No.	List Price
V38-166	Ultra Flow Lid Clamp (pre-94) Americana 1 & 2 (with Knob)	39303000	\$72.00
V38-163	Volute Clamp (with Knob)	39302800	\$77.85

ULTRA FLOW PUMP BASKET

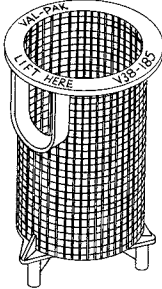

Val-Pak Part No.	Description	OEM Part No.	List Price
V38-185	Ultra Flow Pump Basket (12/Box)	39303500	\$30.96

AMERICAN PRODUCTS SKIMMER PARTS

AMERICAN TAPERED SKIMMER BASKET

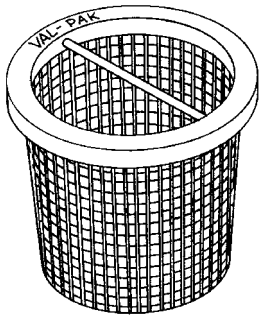

Val-Pak Part No.	Description	OEM Part No.	List Price
V38-125	Tapered Skimmer Basket (20/Box)	85014500	\$23.43

BRASS DIVERter

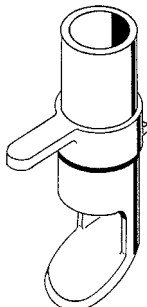

Val-Pak Part No.	Description	OEM Part No.	List Price
V38-099	Brass Diverter (Vari-Flo)	850025	\$121.62

AMERICAN PRODUCTS SKIMMER PARTS

THREAD LOCK DIVERTER

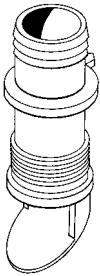

**Val-Pak
Part No.**
V38-100

Description
Thread Lock Diverter

**List
Price**
\$21.75

COMMERCIAL DIVERTER

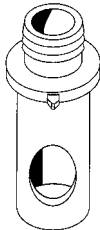

**Val-Pak
Part No.**
V38-101

Description
Commercial Diverter

**List
Price**
\$28.31

AMERICAN SKIMMER LID

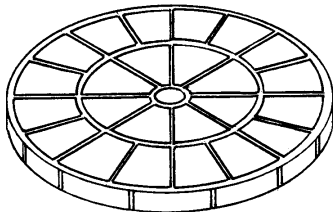

**Val-Pak
Part No.**

Description

V50-115W American Skimmer Lid (White) 9¹/₈" dia.
 V50-115G American Skimmer Lid (Gray) 9¹/₈" dia.
 V50-115T American Skimmer Lid (Tan) 9¹/₈" dia.
 V50-115R American Skimmer Lid (Red) 9¹/₈" dia.
 V50-115GN American Skimmer Lid (Green) 9¹/₈" dia.

**List
Price**
\$ 9.20
\$ 9.20
\$ 9.20
\$ 9.20
\$ 9.20

THROTTLING PLUG W/O-RING

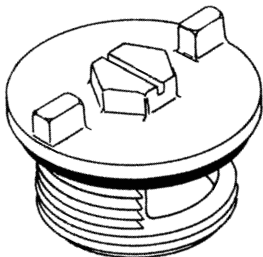

**Val-Pak
Part No.**
V50-350

Description
1¹/₂" Throttling Plug with O-Ring



**List
Price**
\$ 9.63

AMERICAN PRODUCTS RETURN FITTINGS

RETURN FITTING

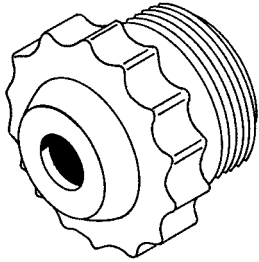

Val-Pak Part No.	Description	List Price
V20-386	Return Fitting - White 1/2"	\$ 3.45
V20-387	Return Fitting - White 3/4"	\$ 3.45
V20-388	Return Fitting - White 1"	\$ 3.45
V20-406	Return Fitting - Black 1/2"	\$ 3.45
V20-391	Return Fitting - Black 3/4"	\$ 3.45
V20-392	Return Fitting - Black 1"	\$ 3.45
V20-394	Return Fitting - Light Gray 1/2"	\$ 3.45
V20-395	Return Fitting - Light Gray 3/4"	\$ 3.45
V20-396	Return Fitting - Light Gray 1"	\$ 3.45
V20-398	Return Fitting - Dark Gray 1/2"	\$ 3.45
V20-399	Return Fitting - Dark Gray 3/4"	\$ 3.45
V20-400	Return Fitting - Dark Gray 1"	\$ 3.45

BLANK RETURN FITTING

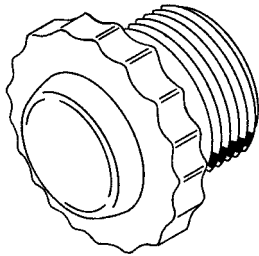

Val-Pak Part No.	Description	List Price
V20-377	Blank Return Fitting - White	\$ 4.20
V20-378	Blank Return Fitting - Black	\$ 4.20
V20-379	Blank Return Fitting - Dark Gray	\$ 4.20
V20-380	Blank Return Fitting - Light Gray	\$ 4.20

90 DEGREE RETURN FITTING

**Available
Spring 2007**

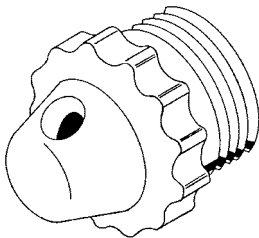

Val-Pak Part No.	Description	List Price
V20-415	90 Degree Return Fitting - White	\$ 5.48
V20-416	90 Degree Return Fitting - Black	\$ 5.48
V20-417	90 Degree Return Fitting - Dark Gray	\$ 5.48
V20-418	90 Degree Return Fitting - Light Gray	\$ 5.48

WALL FITTING WRENCH

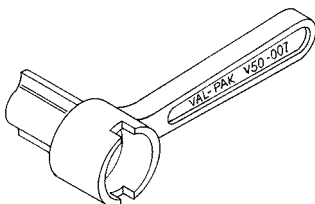

Val-Pak Part No.	Description	List Price
V50-007	Eyeball Fitting Removal Wrench	\$75.00

AMERICAN PRODUCTS FILTER PARTS

FILTER GRID, FULL & PARTIAL

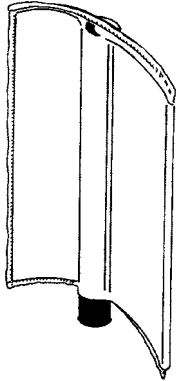

Val-Pak Part No.	Description	List Price
V38-190	24' Filter Grid - Full (25/Box)	\$22.90
V38-191	36' Filter Grid - Full (25/Box)	\$29.32
V38-192	48' Filter Grid - Full (25/Box)	\$35.93
V38-193	60' Filter Grid - Full (25/Box)	\$44.14
V38-194	72' Filter Grid - Full (25/Box)	\$50.37
V38-195	24' Filter Grid - Partial (8/Box)	\$25.82
V38-196	36' Filter Grid - Partial (8/Box)	\$31.01
V38-197	48' Filter Grid - Partial (8/Box)	\$38.19
V38-198	60' Filter Grid - Partial (8/Box)	\$42.01
V38-199	72' Filter Grid - Partial (8/Box)	\$52.15

COMMANDER FILTER LID, KNOB, O-RING

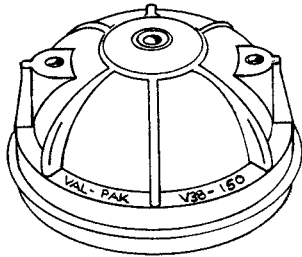

Val-Pak Part No.	Description	OEM Part No.	List Price
V38-150	Commander Filter Lid	57005600	\$90.75
V38-152	Commander Filter Knob	57006900	\$29.85
V38-151	Filter Lid O-Ring	57007300	\$ 3.66

FNS PLUS TOP MANIFOLD

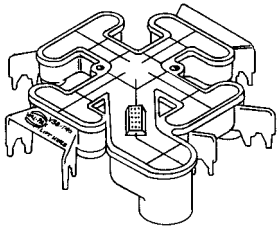

Val-Pak Part No.	Description	OEM Part No.	List Price
V38-140	FNS Plus/American Top Manifold with Air-Relief Screen (12/Box)	59023700 59000400	\$86.25

QUANTUM MANIFOLD & GASKET

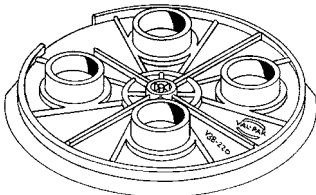

Val-Pak Part No.	Description	OEM Part No.	List Price
V38-220	Manifold — CM, RPM & S.S.	56626800	\$77.85
V38-221	Manifold Gasket — CM, RPM & S.S.	57000300	\$79.50

QUANTUM MANIFOLD SUPPORT RING

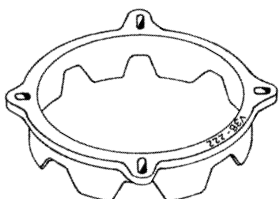

Val-Pak Part No.	Description	OEM Part No.	List Price
V38-222	Quantum Manifold Support Ring	59004000	\$24.00

AMERICAN PRODUCTS FILTER PARTS (Continued)

PISTON & SHAFT

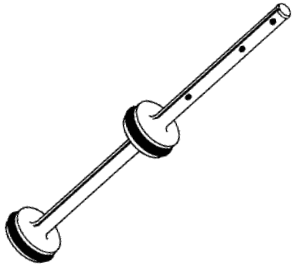

Val-Pak Part No.	Description	List Price
V38-104	Piston & Shaft 1½" - 16" Long w/O-Rings	\$135.00
V38-111	Piston & Shaft 1½" - 18" Long w/O-Rings	\$135.00
V38-105	Piston & Shaft 2" - 16" Long w/O-Rings	\$150.00

PISTON O-RING SET

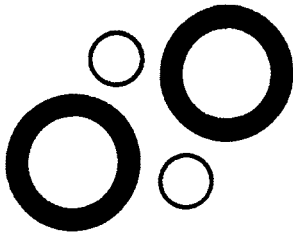

Val-Pak Part No.	Description	List Price
V38-102	Piston O-Ring Set 1½" (25/Bag)	\$ 3.36
V38-103	Piston O-Ring Set 2" Brass Old Style (25/Bag)	\$ 3.36
V38-121	Piston O-Ring Set 2" Plastic New Style (25/Bag)	\$ 3.36

AIR RELIEF VALVE

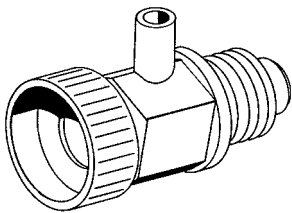

Val-Pak Part No.	Description	OEM Part No.	List Price
V38-115	Celcon Air Relief Valve 1/4" (50/Bag)	982058	\$ 9.45
V38-156	Repl. Valve Stem O-Ring (100/Bag)		\$.42

TIE ROD



Val-Pak Part No.	Description	OEM Part No.	List Price
V38-106	Tie Rod 15½" 24 Sq. Ft.	590008	\$ 22.50
V38-107	Tie Rod 21½" 36 Sq. Ft.	590015	\$ 25.05
V38-108	Tie Rod 27½" 48 Sq. Ft.	590021	\$ 28.20
V38-109	Tie Rod 33½" 60 Sq. Ft.	590027	\$ 28.20
V38-110	Tie Rod 39½" 72 Sq. Ft.	590033	\$ 31.50

ANTHONY PUMP PARTS

AR PUMP IMPELLER

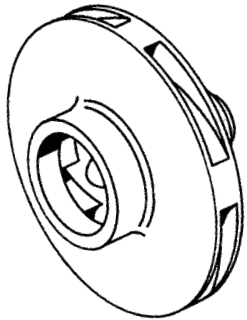

Val-Pak Part No.	Description	List Price
V34-001	3/4 Horsepower Impeller	\$ 77.67
V34-002	1 Horsepower Impeller	\$ 77.67
V34-003	1½ Horsepower Impeller	\$ 91.83
V34-004	2 Horsepower Impeller	\$ 92.89
V34-005	2½ Horsepower Impeller	\$ 93.78

SEAL PLATE, O-RING

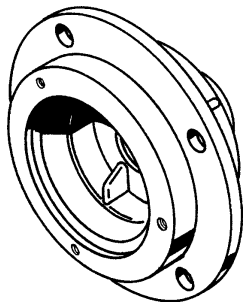

Val-Pak Part No.	Description	List Price
V34-006	Brass Seal Plate — AR Pump	\$360.00
V34-012	Seal Plate O-Ring — AR Pump	\$ 11.57

BRASS IMPELLER

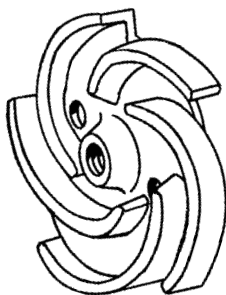

Val-Pak Part No.	Description	OEM Part No.	List Price
V40-452	1/3 Horsepower Impeller		\$ 89.85
V40-453	1/2 Horsepower Impeller	04381	\$ 80.85
V40-454	3/4 Horsepower Impeller	06323	\$ 80.85
V40-455	1 Horsepower Impeller	06324	\$ 80.85
V40-456	1½ Horsepower Impeller	06325	\$ 80.85
V40-457	2 Horsepower Impeller	06326	\$ 80.85
V40-458	3 Horsepower Impeller		\$ 89.85

ANTHONY PUMP PARTS (Continued)

ADAPTER BRACKET

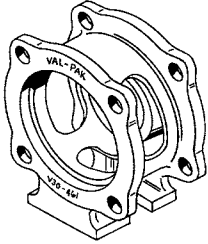

Val-Pak Part No.	Description	OEM Part No.	List Price
V30-461	1/3-3 Horsepower Bracket (w/Foot)	004378	\$218.25

PUMP SHAFT, GASKET, SET SCREW

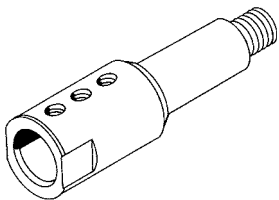

Val-Pak Part No.	Description	OEM Part No.	List Price
V40-116	Pump Shaft (10/Bag)	004377	\$ 19.50
V40-115	H & F Gasket (12/Bag)	G44	\$ 2.10
V40-401	1/4 x 20 Set Screw S.S. (100/Bag)		\$.93

LOCK HANDLE

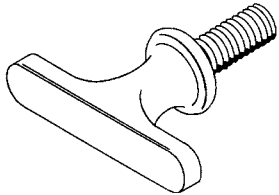

Val-Pak Part No.	Description	OEM Part No.	List Price
V40-468	Lock Handle, Bronze/S.S. Stud	004390	\$ 21.00

DIFFUSER, O-RING

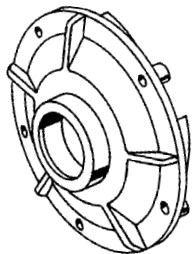

Val-Pak Part No.	Description	List Price
V34-011	Diffuser 1-2½ Horsepower - AR Pump	\$ 26.19
V34-013	Diffuser Seal O-Ring - AR Pump	\$ 16.99

ANTHONY HEATER PART

HEADER

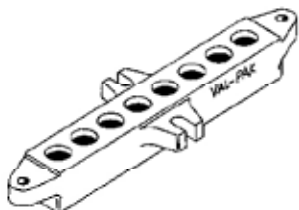

Val-Pak Part No.	Description	OEM Part No.	List Price
V34-014	Heater Return Header	15977	\$195.00

ANTHONY 1½" & 2" SELECTOR VALVE EXPLODED VIEW

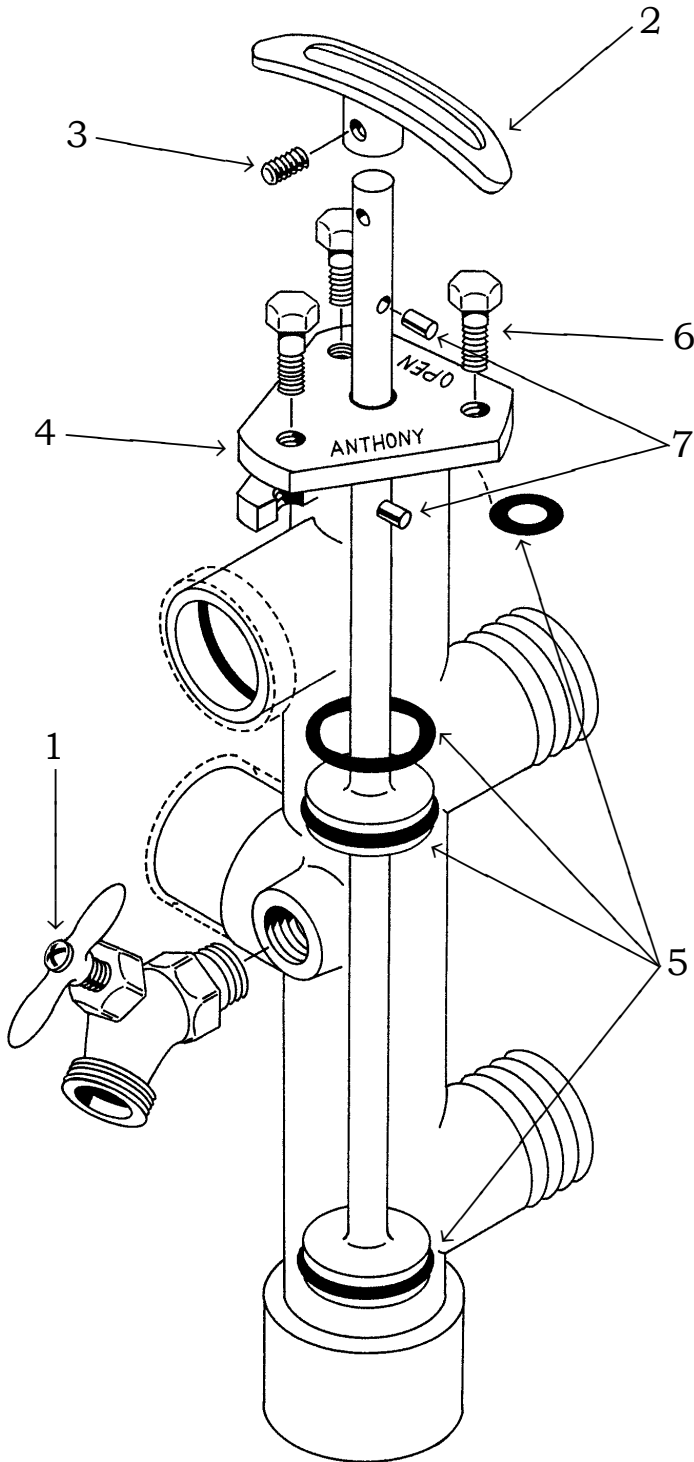

1½" VALVE

KEY NO.	PART DESCRIPTION	PART NO.
1.	Hose Bib	V34-169
2.	Handle w/Screw	V34-127
3.	Set Screw	V34-135
4.	Cap	V34-152
5.	O-Ring Kit	V34-115
6.	Screw	V34-170
7.	Spring Pin	V34-021
8.	Hose Coupling	V34-172 (Rubber, w/S.S. Clamp)

Piston & ShaftV34-015
(Includes Spring Pins
& O-Rings)

Piston, Cap & HandleV34-016
(Includes Set Screw,
Spring Pins & O-Rings)

2" VALVE

KEY NO.	PART DESCRIPTION	PART NO.
1.	Hose Bib	V34-169
2.	Handle w/Screw	V34-127
3.	Set Screw	V34-135
4.	Cap	V34-153
5.	O-Ring Kit	V34-120
6.	Screw	V34-170
7.	Spring Pin	V34-021
8.	Hose Coupling	V34-171 (Rubber, w/S.S. Clamp, See Pg. 16)

Piston & ShaftV34-020
(Includes Spring Pins
& O-Rings)

Piston, Cap & HandleV34-022
(Includes Set Screw,
Spring Pins & O-Rings)

ANTHONY BACKWASH VALVE PARTS

PISTON, CAP & HANDLE

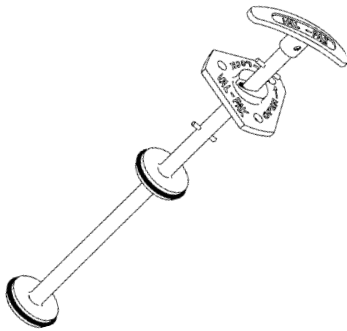

Val-Pak Part No.	Description	OEM Part No.	List Price
V34-016	Piston, Cap & Handle 1½" (Brass)	004906	\$242.34
V34-022	Piston, Cap & Handle 2" (Brass)	004908	\$262.50

PISTON & SHAFT w/ O-RINGS

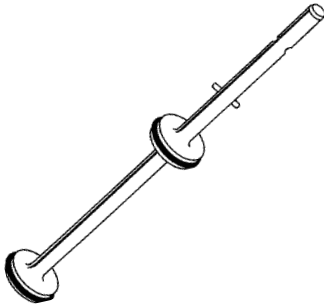

Val-Pak Part No.	Description	OEM Part No.	List Price
V34-015	Piston & Shaft 1½" - 16½" in length	004907	\$151.50
V34-140	Piston & Shaft 1½" - 17½" in length	N/A	\$225.00
V34-020	Piston & Shaft 2" - 16½" in length	004909	\$163.50

PISTON CAP



Val-Pak Part No.	Description	OEM Part No.	List Price
V34-152	Piston Cap 1½", Brass	17754	\$ 53.25
V34-153	Piston Cap 2", Brass	17753	\$ 72.75

PISTON HANDLE

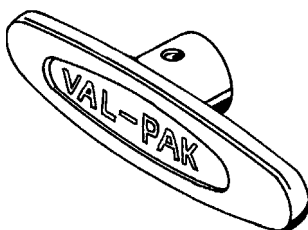

Val-Pak Part No.	Description	OEM Part No.	List Price
V34-127	Piston Handle with Set Screw	17604	\$ 22.50

ANTHONY BACKWASH VALVE PARTS (Continued)

BACKWASH HANDLE SET SCREW



Val-Pak Part No.	Description	OEM Part No.	List Price
V34-135	1/4" S.S. Set Screw (25/Bag)	24951	\$ 1.49

RUBBER HOSE

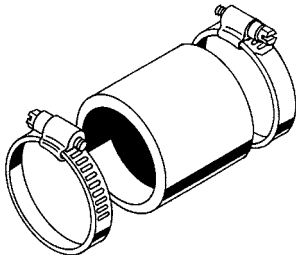

Val-Pak Part No.	Description	List Price
V34-171	2" Rubber Hose with S.S. Clamp (2 Hoses, 4 Clamps)	\$ 41.85
V34-172	1 1/2" Rubber Hose with S.S. Clamp (2 Hoses, 4 Clamps)	\$ 38.85

PISTON O-RING SET

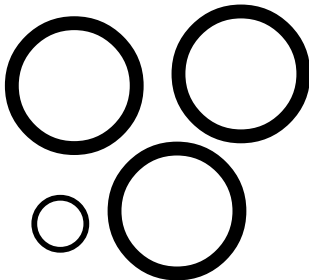

Val-Pak Part No.	Description	List Price
V34-115	Piston O-Ring Set 1 1/2" Brass (25/Bag)	\$ 3.36
V34-120	Piston O-Ring Set 2" Brass (25/Bag)	\$ 3.36
V34-141	Piston O-Ring Set 2" Plastic (25/Bag)	\$ 3.96

SPRING PIN

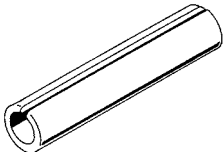

Val-Pak Part No.	Description	List Price
V34-021	Spring Pin, S.S. (25/Bag)	\$ 1.56

SELECTOR VALVE



Val-Pak Part No.	Description	List Price
V34-168	2" Brass Selector Valve (Threaded), Complete	\$608.85

ANTHONY APOLLO FILTER EXPLODED VIEW

MODELS VA-26, VA-32, VA-38, VA-52, & VA-52-2"

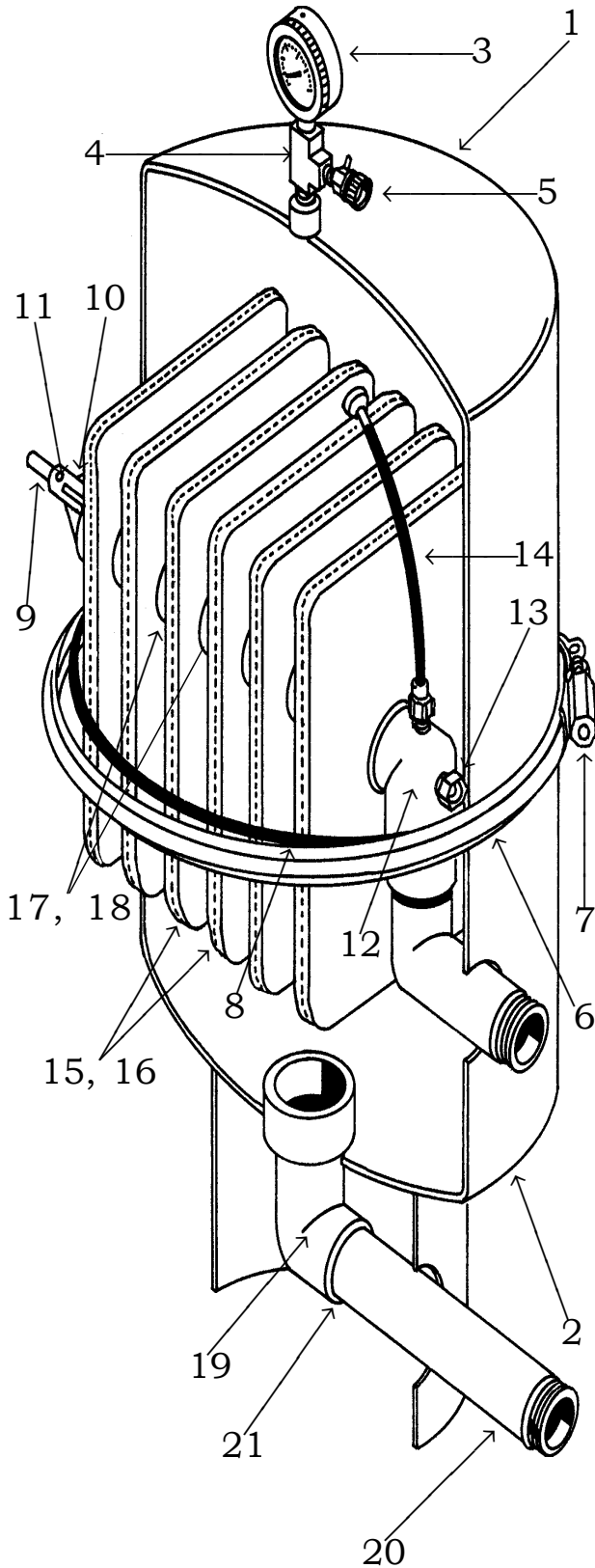

PART DESCRIPTION	PART NUMBER (by filter size)				
	VA-26	VA-32	VA-38	VA-52	VA-52-2"
1. TOP SHELL ASSY.	V34-157	V34-157	V34-157	V34-158	V34-158
2. BOTTOM SHELL ASSY.	V34-159	V34-159	V34-159	V34-160	V34-160
3. PRESSURE GAUGE	V34-161	V34-161	V34-161	V34-161	V34-161
4. BRASS TEE	V34-162	V34-162	V34-162	V34-162	V34-162
5. AIR RELIEF VALVE	V38-115	V38-115	V38-115	V38-115	V38-115
6. TANK CLAMP W/NUT	V34-132	V34-132	V34-132	V34-133	V34-133
7. BRASS NUT 5/16 X 24	V34-151	V34-151	V34-151	V34-151	V34-151
8. O-RING	V34-154	V34-154	V34-154	V34-139	V34-139
9. SHAFT	V34-125	V34-125	V34-125	V34-126	V34-126
10. REAR END BELL w/Screw	V34-122	V34-122	V34-122	V34-122	V34-122
11. SET SCREW	V34-123	V34-123	V34-123	V34-123	V34-123
12. COLLECTION ELBOW	V34-130	V34-130	V34-130	V34-130	V34-131
13. INSERT NUT (Brass)	V34-121	V34-121	V34-121	V34-121	V34-121
14. AIR BLEED ASSY.	V34-136	V34-136	V34-136	V34-136	V34-136
15. GRIDS (13½" X 24")	V34-128	V34-128	V34-128	V34-128	V34-128
16. GRIDS (17½" X 24")	NONE	V34-129	V34-129	V34-129	V34-129
17. SPACERS (1" wide)	NONE	V34-149	V34-149	V34-149	V34-149
18. SPACERS (1½" wide)	V34-150	V34-150	NONE	NONE	NONE
19. INLET ELBOW	V34-163	V34-163	V34-163	V34-163	V34-163
20. INLET PIPE	V34-166	V34-166	V34-166	V34-166	V34-164
21. BUSHING	V34-167	V34-167	V34-167	V34-167	NONE
GRID ASSEMBLY (Complete) Includes Items 9 thru 18)	V34-147	V34-146	V34-145	V34-144	V34-143

GRID LINEUP CHART

MODEL NUMBER	GRIDS (Left to Right)									
	1	2	3	4	5	6	7	8	9	10
VA-26	13½"	13½"	13½"	13½"	13½"	13½"				
VA-32	13½"	13½"	13½"	17½"	13½"	13½"	13½"			
VA-38	13½"	13½"	13½"	17½"	17½"	13½"	13½"	13½"		
VA-52	13½"	13½"	17½"	17½"	17½"	17½"	17½"	17½"	13½"	13½"
VA-52-2"	13½"	13½"	17½"	17½"	17½"	17½"	17½"	17½"	13½"	13½"

SPACER LINEUP CHART

MODEL NUMBER	SPACERS (Left to Right)								
	1	2	3	4	5	6	7	8	9
VA-26	1½"	1½"	1½"	1½"	1½"				
VA-32	1½"	1"	1"	1"	1"	1½"			
VA-38	1"	1"	1"	1"	1"	1"	1"		
VA-52	1"	1"	1"	1"	1"	1"	1"	1"	1"
VA-52-2"	1"	1"	1"	1"	1"	1"	1"	1"	1"

ANTHONY FILTER PARTS

GRID ASSEMBLY

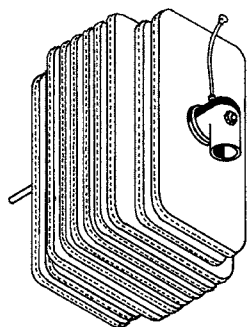

Val-Pak Part No.	Description	OEM Part No.	List Price
V34-143	Grid Assembly, Complete VA-52-2"	04794	\$540.00
V34-144	Grid Assembly, Complete VA-52-1½"	04773	\$540.00
V34-145	Grid Assembly, Complete VA-38	04772	\$450.00
V34-146	Grid Assembly, Complete VA-32	04771	\$450.00
V34-147	Grid Assembly, Complete VA-26	04770	\$450.00

FILTER GRID

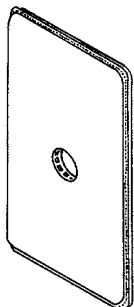

Val-Pak Part No.	Description	OEM Part No.	List Price
V34-128	13½" x 24" Grid (25/Bag)	017564	\$ 26.08
V34-129	17½" x 24" Grid (25/Bag)	017565	\$ 31.01

FILTER LID

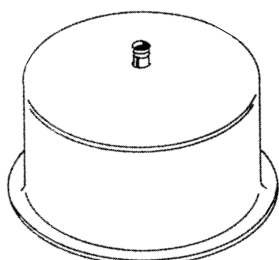

Val-Pak Part No.	Description	List Price
V34-157	Top Shell Assembly (VA 26-32-38) 13" x 18½" dia.	\$ 525.00
V34-158	Top Shell Assembly (VA 52 1½" & 2") 12¼" x 21" dia.	\$ 555.00
V34-160	Bottom Shell Assembly (VA 52 2") 20"	\$1050.00

TANK LID O-RING

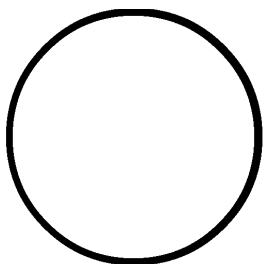

Val-Pak Part No.	Description	OEM Part No.	List Price
V34-154	Tank Lid O-Ring 18" (25/Bag)	17433	\$ 13.32
V34-139	Tank Lid O-Ring 20" (25/Bag)	17434	\$ 15.66

ANTHONY FILTER PARTS (Continued)

FILTER SHAFT

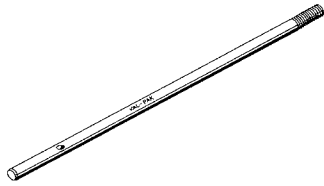

Val-Pak Part No.	Description	OEM Part No.	List Price
V34-125	Filter Shaft 17¼"	017007	\$ 44.16
V34-126	Filter Shaft 19¾"	017006	\$ 45.75

COLLECTION ELBOW

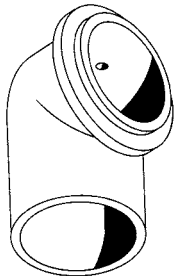

Val-Pak Part No.	Description	OEM Part No.	List Price
V34-130	Collection Elbow 1½"	017572	\$ 23.85
V34-131	Collection Elbow 2"	017571	\$ 23.85
V34-163	Inlet Elbow 2"	017525	\$ 23.85

INLET PIPE

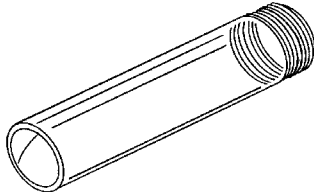

Val-Pak Part No.	Description	List Price
V34-164	Inlet Pipe 2"	\$ 51.00
V34-166	Inlet Pipe 1½"	\$ 51.00

AIR BLEED ASSEMBLY

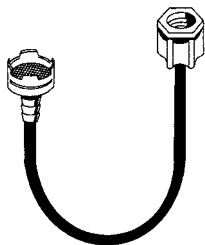

Val-Pak Part No.	Description	List Price
V34-136	Internal Air Bleed Assembly (10/Bag)	\$ 11.55

INSERT NUT

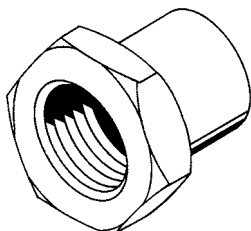

Val-Pak Part No.	Description	OEM Part No.	List Price
V34-121	Insert Nut, Brass (10/Bag)	017576	\$ 9.75

ANTHONY FILTER PARTS (Continued)

GRID SPACER

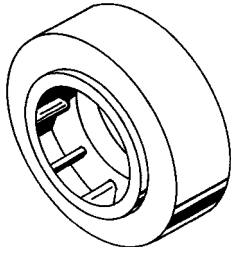

Val-Pak Part No.	Description	OEM Part No.	List Price
V34-148	Grid Spacer, 3/4"		\$ 9.75
V34-149	Grid Spacer, 1"	017430	\$ 9.75
V34-150	Grid Spacer, 1 1/2"	017575	\$ 21.00

REAR END BELL

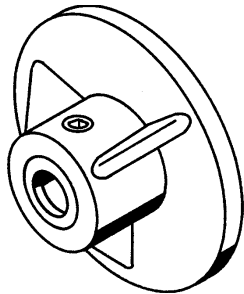

Val-Pak Part No.	Description	OEM Part No.	List Price
V34-122	Rear End Bell (w/Set Screw)	017410	\$ 27.00

SET SCREW



Val-Pak Part No.	Description	OEM Part No.	List Price
V34-123	Set Screw - Rear End Bell (25/Bag)	024924SS	\$ 1.49

PRESSURE GAUGE

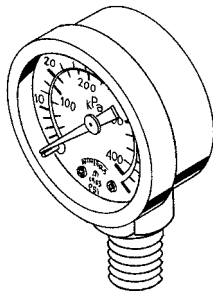

Val-Pak Part No.	Description	List Price
V34-161	1/4" Pressure Gauge 0-60 PSI	\$ 9.20

BRASS TEE

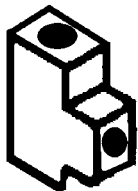

Val-Pak Part No.	Description	List Price
V34-162	1/4" Brass Tee	\$ 9.30

ANTHONY FILTER PARTS (Continued)

TANK CLAMP

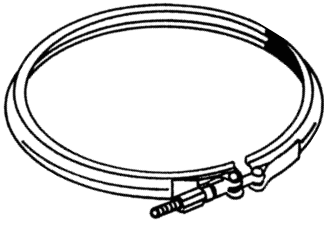

Val-Pak Part No.	Description	OEM Part No.	List Price
V34-132	Tank Clamp, 18"	017745	\$111.75
V34-133	Tank Clamp, 20"	017746	\$116.85

TANK CLAMP NUT

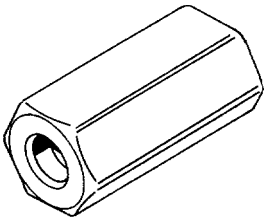

Val-Pak Part No.	Description	OEM Part No.	List Price
V34-151	Tank Clamp Nut N/S Brass (25/Bag)	017762	\$ 3.30

AIR RELIEF VALVE

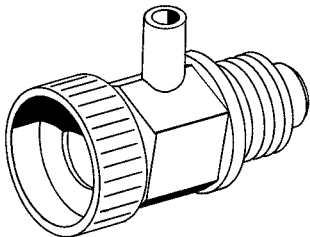

Val-Pak Part No.	Description	OEM Part No.	List Price
V38-115	Celcon Air Relief Valve 1/4" (50/Bag)	002732	\$ 9.45
V38-156	Repl. Valve Stem O-Ring (100/Bag)		\$.42

ANTHONY LIGHT PARTS

FACE RING LIGHT SCREW W/RETAINER

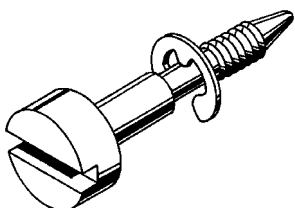

Val-Pak Part No.	Description	OEM Part No.	List Price
V34-138	Face Ring Light Screw with Retainer (10/Bag)	014434	\$ 8.85

ANTHONY SKIMMER PARTS

DIVERTER VALVE

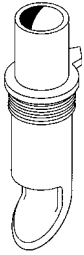

**Val-Pak
Part No.**
V34-124

Description
Diverter Valve O/S

**OEM
Part No.**
5227

**List
Price**
\$ 41.85

LONG DIVERTER

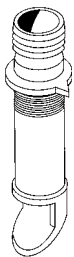

**Val-Pak
Part No.**
V34-134

Description
Long Diverter for U-3 Skimmer

**OEM
Part No.**
6683

**List
Price**
\$ 54.75

THREAD LOCK DIVERTER

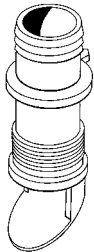

**Val-Pak
Part No.**
V38-100

Description
Thread Lock Diverter

**OEM
Part No.**
6414

**List
Price**
\$ 21.75

SKIMMER BASKET

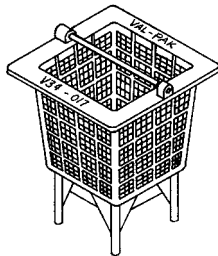

**Val-Pak
Part No.**
V34-017

Description
Anthony 7"X7" Skimmer Basket (18/Box)

**List
Price**
\$ 17.85

SKIMMER LID

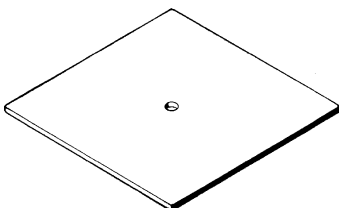

**Val-Pak
Part No.**
V34-018

Description
Skimmer Lid, 9"X9" for Anthony Precast Skimmer

**List
Price**
\$ 56.85

A.O. SMITH HEATER PARTS

225 PILOT

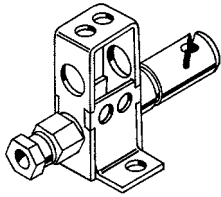

**Val-Pak
Part No.**
V44-108

Description
225 Pilot

**OEM
Part No.**
96666

**List
Price**
\$ 89.04

300, 390 & 420 PILOT

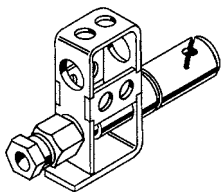

**Val-Pak
Part No.**
V44-109

Description
300, 390 & 420 Pilot

**OEM
Part No.**
2587-1

**List
Price**
\$118.46

COIL LIMIT SWITCH

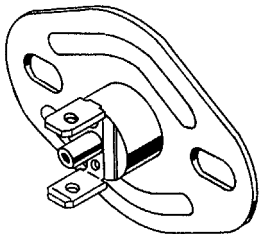

**Val-Pak
Part No.**
V44-112

Description
160 Coil Limit

**OEM
Part No.**
69891-1

**List
Price**
\$153.05

PILOT SHIELD

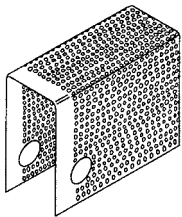

**Val-Pak
Part No.**
V44-114

Description
Pilot Shield

**OEM
Part No.**
94648

**List
Price**
\$ 17.69

GAS VALVE

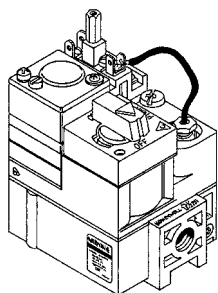

**Val-Pak
Part No.**
V44-103
V44-104

Description
225 & 300 Gas Valve
390 & 420 Gas Valve

**OEM
Part No.**
4961-1
4960

**List
Price**
\$609.01
\$666.16

A.O. SMITH HEATER PARTS (Continued)

DRY WELL

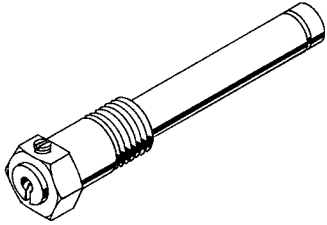

Val-Pak Part No.	Description	OEM Part No.	List Price
V44-101	Dry Well, 1/2"	97949	\$ 84.27
V44-111	Dry Well, 3/4"	94949-1	\$ 85.70

THERMOSTAT

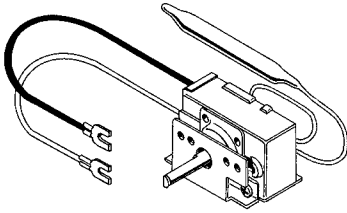

Val-Pak Part No.	Description	OEM Part No.	List Price
V44-100	Thermostat	99676-2	\$187.62

HIGH LIMIT SWITCH

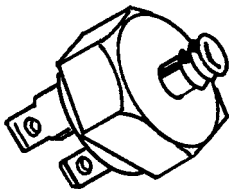

Val-Pak Part No.	Description	OEM Part No.	List Price
V44-105	160 High Limit	69816-2	\$214.98
V44-106	130 High Limit	76752	\$108.50

**Call Us For Additional
A.O. Smith Replacement Parts**

AQUA-FLO PUMP PARTS

BRASS IMPELLER

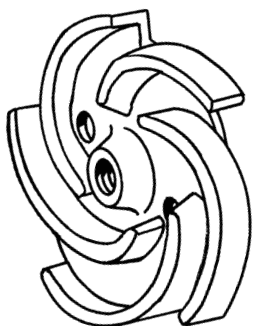

Val-Pak Part No.	Description	OEM Part No.	List Price
V40-452	1/3 Horsepower Impeller		\$ 89.85
V40-453	1/2 Horsepower Impeller	91691051	\$ 80.85
V40-454	3/4 Horsepower Impeller	91691100	\$ 80.85
V40-455	1 Horsepower Impeller	91691151	\$ 80.85
V40-456	1½ Horsepower Impeller	91691201	\$ 80.85
V40-457	2 Horsepower Impeller	91691251	\$ 80.85
V40-458	3 Horsepower Impeller		\$ 89.85

5" PUMP BASKET

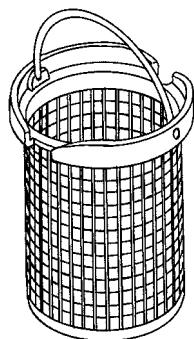

Val-Pak Part No.	Description	List Price
V40-465	5" Pump Basket (24/Box)	\$ 19.50

BRASS BRACKET

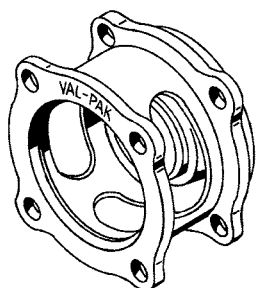

Val-Pak Part No.	Description	OEM Part No.	List Price
V40-460	1/3-3 Horsepower Bracket (w/out Foot)	91140050	\$208.50

PUMP SHAFT, SET SCREW

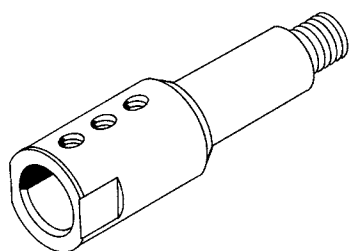

Val-Pak Part No.	Description	List Price
V40-116	Pump Shaft (10/Bag)	\$ 19.50
V40-401	1/4 X 20 Set Screw S.S. (100/Bag)	\$.93

AQUA-FLO PUMP PARTS (Continued)

TRAP HANDLE

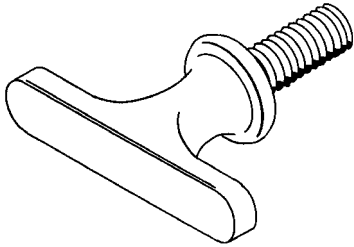

Val-Pak Part No.	Description	OEM Part No.	List Price
V40-468	Trap Handle, S.S. Stud	91920001	\$ 21.00

H & F GASKET, TRAP GASKET, LID O-RING

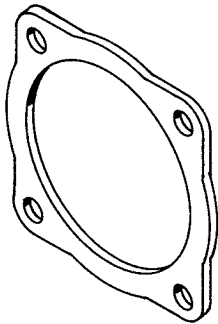

Val-Pak Part No.	Description	OEM Part No.	List Price
V40-115	H & F Gasket (12/Bag)	G44	\$ 2.10
V40-118	Trap Gasket (12/Bag)	G57	\$ 1.08
V40-117	Pump Lid O-Ring, 5" (12/Bag)	080	\$ 2.83

5" BRASS PUMP LID

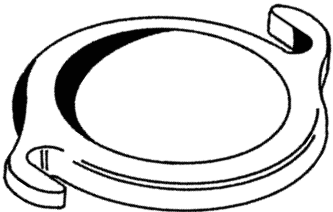

Val-Pak Part No.	Description	List Price
V40-463	5" Brass Pump Lid	\$ 71.70

**Call Us For Our Full Line
Of Aqua-Flo Residential & Commercial
Pumps and Replacement Parts**

DOMINATOR PUMP PARTS

IMPELLER, SCREW

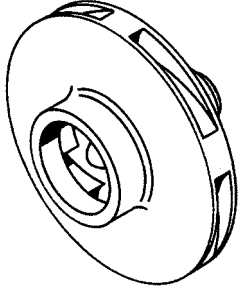

Val-Pak Part No.	Description	OEM Part No.	List Price
V40-411	3/4 HP Medium-Head Impeller	91692455	\$ 68.85
V40-412	1 HP Medium-Head Impeller	91692505	\$ 68.85
V40-413	1½ HP Medium-Head Impeller	91692555	\$ 68.85
V40-414	2 HP Medium-Head Impeller	91692605	\$ 68.85
V40-416	3/4 HP High-Head Impeller	91692450	\$ 68.85
V40-417	1 HP High-Head Impeller	91692500	\$ 68.85
V40-418	1½ HP High-Head Impeller	91692550	\$ 68.85
V40-419	2 HP High-Head Impeller	91692600	\$ 68.85
V40-427	M-H Impeller Screw (10/Bag)	99730160	\$ 4.74
V40-428	H-H Impeller Screw (10/Bag)	99730150	\$ 4.74

DIFFUSER, SCREW

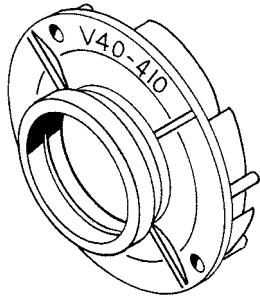

Val-Pak Part No.	Description	OEM Part No.	List Price
V40-410	Medium-Head Diffuser	91270020	\$ 33.75
V40-415	High-Head Diffuser	91270002	\$ 33.75
V40-425	M-H Diffuser Screw (25/Bag)	99730550	\$.32
V40-426	H-H Diffuser Screw (25/Bag)	99730060	\$.32

BASKET

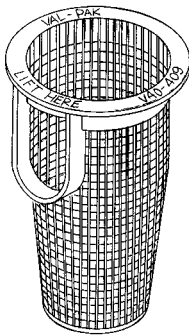

Val-Pak Part No.	Description	OEM Part No.	List Price
V40-409	Dominator Pump Basket (12/Box)	91110040	\$ 13.20

PUMP LID

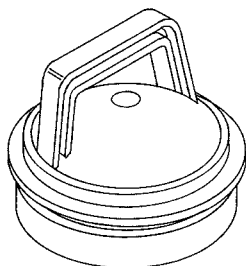

Val-Pak Part No.	Description	OEM Part No.	List Price
V40-430	Dominator Pump Lid	91230300	\$ 36.75

DOMINATOR PUMP PARTS (Continued)

VOLUTE

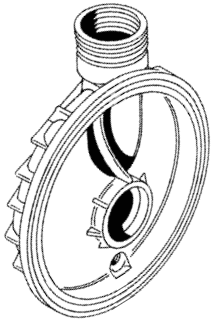

**Val-Pak
Part No.**
V40-900

Description
Dominator Volute

**OEM
Part No.**
91200003

**List
Price**
\$114.00

SEAL PLATE

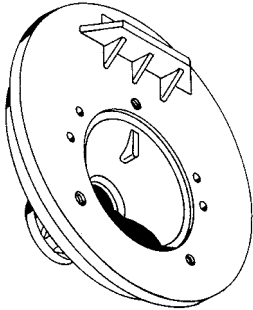

**Val-Pak
Part No.**
V40-901

Description
Dominator Seal Plate
(Replacement Seal 200)

**OEM
Part No.**
92280003

**List
Price**
\$105.00

**Call Us For Additional
Dominator Replacement Parts**

HAYWARD REPLACEMENT BASKETS

HAYWARD SUPER II PUMP BASKET

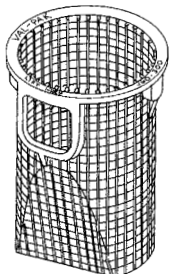

Val-Pak Part No.	Description	OEM Part No.	List Price
V60-300	Hayward Super II Pump Basket (12/Box)	SPX3000M	\$ 12.30

HAYWARD LEAF CANNISTER BASKET

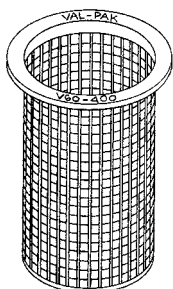

Val-Pak Part No.	Description	OEM Part No.	List Price
V60-400	Std. Leaf Cannister Basket (16/Box)	AXW431A	\$ 11.10

HAYWARD SKIM-MASTER BASKET

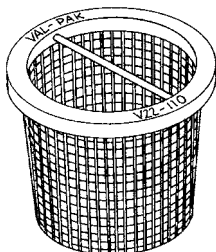

Val-Pak Part No.	Description	OEM Part No.	List Price
V22-110	Skim-Master Basket (28/Box)	SPX1070E	\$ 20.91

HAYWARD SUPER PUMP BASKET

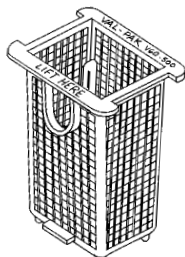

Val-Pak Part No.	Description	OEM Part No.	List Price
V60-500	Hayward Super Pump Basket (18/Box)	SPX1600M	\$ 12.60

HAYWARD 1082 SKIMMER BASKET

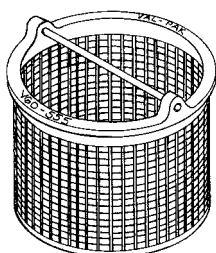

Val-Pak Part No.	Description	OEM Part No.	List Price
V60-555	SP1082 & SP1084 Skimmer Basket (12/Box)	SPX1082CA	\$ 20.91

HAYWARD REPLACEMENT PARTS

HAYWARD PISTON COMPLETE, O-RING SET

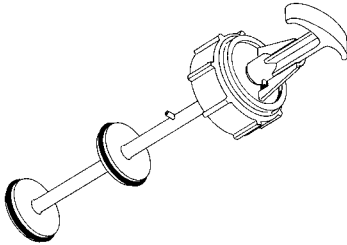

Val-Pak Part No.	Description	List Price
V60-200	Hayward Piston, Cap & Handle - Brass	\$120.00
V60-100	Hayward Backwash Piston O-Ring Set (25/Bag)	\$ 3.36

HAYWARD O-RINGS

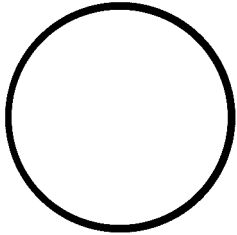

Val-Pak Part No.	Description	List Price
V60-101	CL200 & CL220 Viton Lid O-Ring (12/Bag)	\$ 15.99
V60-301	Hayward Super II Pump Lid O-Ring (12/Bag)	\$ 2.55

HAYWARD CARTRIDGE MANIFOLD

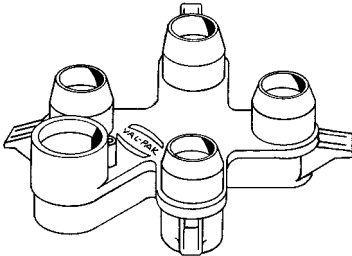

Val-Pak Part No.	Description	OEM Part No.	List Price
V60-550	Hayward Manifold (11/Box) (FOR PLASTIC TANK BODY ONLY)	CX3000C	\$ 54.75

LANDON & MARLIN DECK FILTER PARTS

FILTER ELEMENT

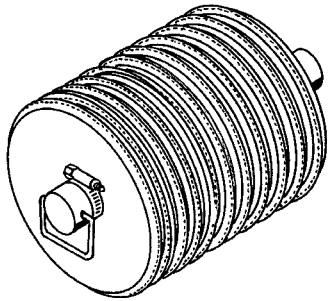

Val-Pak Part No.	Description	List Price
V28-011	11 Plate Element (14½" in length)	\$466.50
V28-015	15 Plate Element (19¼" in length)	\$540.00
V28-018	18 Plate Element (22½" in length)	\$576.00
V28-022	22 Plate Element (27¼" in length)	\$630.00

SKIM FILTER BASKET

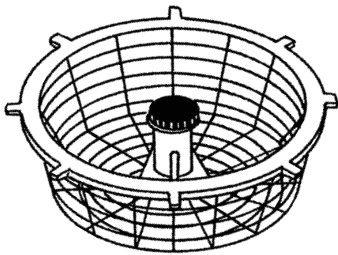

Val-Pak Part No.	Description	List Price
V28-600	Landon Skim Filter Basket	\$ 25.50
V28-601	Marlin Skim Filter Basket	\$ 25.50

VAC LID

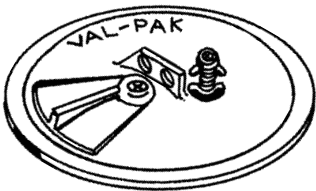

Val-Pak Part No.	Description	List Price
V28-602	Landon Vac Lid 12 ⁷ / ₈ " in Diameter	\$ 85.50
V28-604	Marlin Vac Lid 12½" in Diameter	\$ 85.50

KING SLEEVE

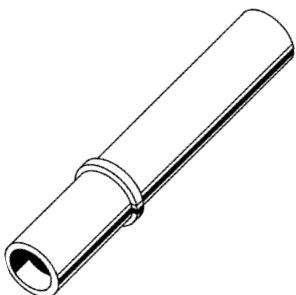

Val-Pak Part No.	Description	List Price
V28-605	King Sleeve, 6"	\$ 22.20
V28-606	King Sleeve, 10"	\$ 31.50
V28-607	King Sleeve, 18"	\$ 45.00

MARTIN 100 SERIES 1/3-3 HORSEPOWER BRASS PUMP

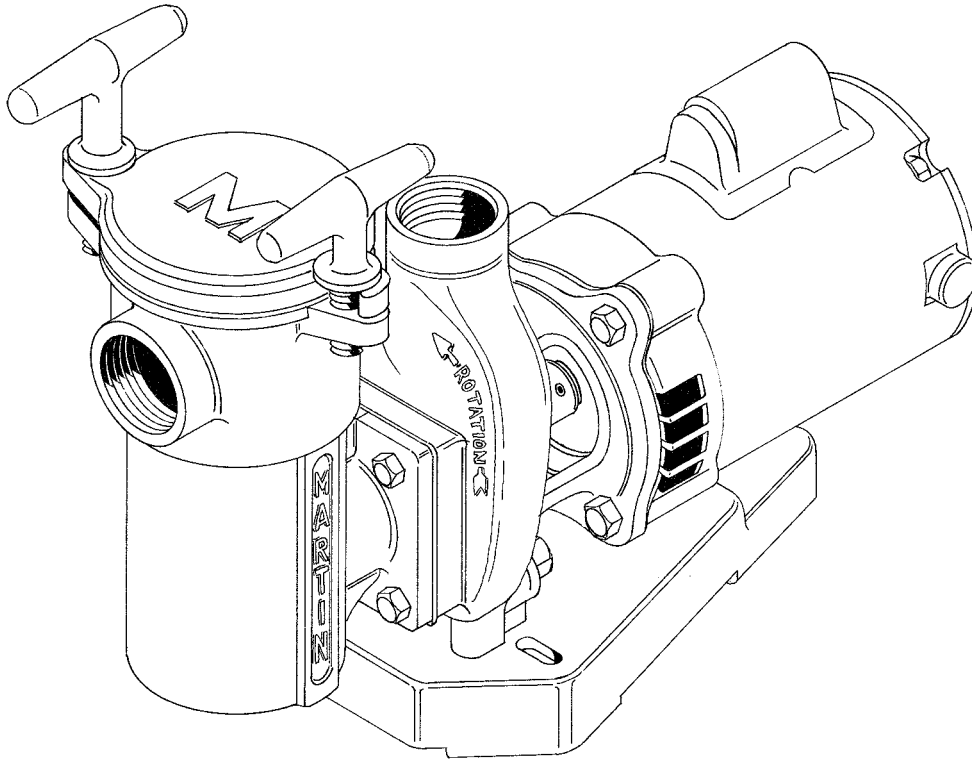

COMPLETE PUMP & MOTOR

Val-Pak Part No.	Description	List Price
V40-504	1/3 Horsepower Pump & Motor, 60Hz, 5" Trap	\$1134.00
V40-505	1/2 Horsepower Pump & Motor, 60Hz, 5" Trap	\$1134.00
V40-506	3/4 Horsepower Pump & Motor, 60Hz, 5" Trap	\$1155.00
V40-507	1 Horsepower Pump & Motor, 60Hz, 5" Trap	\$1173.00
V40-508	1½ Horsepower Pump & Motor, 60Hz, 5" Trap	\$1266.00
V40-509	2 Horsepower Pump & Motor, 60Hz, 5" Trap	\$1374.00
V40-510	3 Horsepower Pump & Motor, 60Hz, 5" Trap	\$1500.00

Martin 100 Series pumps are available with 6" brass trap, 5" clear lid, Viton seal & aluminum pump base at additional cost.

Val-Pak ultra-silent "Balance Flo" pumps also available.

LIQUID END ONLY

Val-Pak Part No.	Description	List Price
V40-534	1/3 Horsepower Pump Liquid End	\$ 840.00
V40-517	1/2 Horsepower Pump Liquid End	\$ 840.00
V40-518	3/4 Horsepower Pump Liquid End	\$ 840.00
V40-519	1 Horsepower Pump Liquid End	\$ 840.00
V40-520	1½ Horsepower Pump Liquid End	\$ 840.00
V40-521	2 Horsepower Pump Liquid End	\$ 840.00
V40-522	3 Horsepower Pump Liquid End	\$ 840.00

MARTIN 100 SERIES 1/3-3 HP BRASS PUMP EXPLODED VIEW

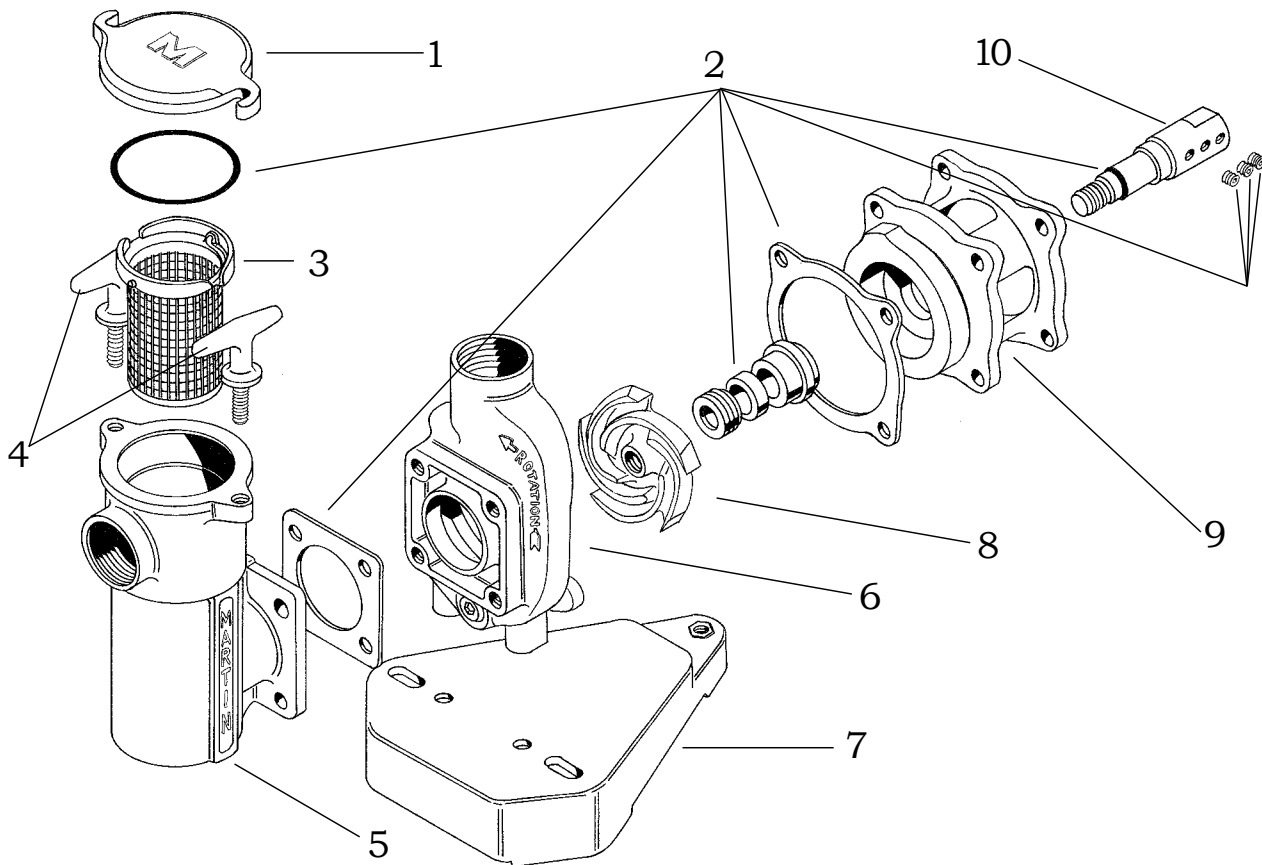

KEY NO.	PART DESCRIPTION	VAL-PAK PART NO.	LIST PRICE
1	5" Brass Pump Lid	V40-463	\$ 71.70
2	Parts Kit (incl. Seal, Gaskets, O-Rings & Set Screws)	V40-481	\$ 75.00
3	5" Pump Basket	V40-465	\$ 19.50
4	Tee Handle, Bronze w/S.S. Stud	V40-468	\$ 21.00
5	5" Brass Trap w/2" NPT	V40-464	\$330.00
6	Brass Volute	V31-458	\$218.25
7	Pump Base (ABS Plastic)	V40-467	\$ 44.55
	Pump Base (Aluminum)	V40-485	\$ 85.65
8	1/3 Horsepower Impeller	V40-452	\$ 89.85
	1/2 Horsepower Impeller	V40-453	\$ 80.85
	3/4 Horsepower Impeller	V40-454	\$ 80.85
	1 Horsepower Impeller	V40-455	\$ 80.85
	1½ Horsepower Impeller	V40-456	\$ 80.85
	2 Horsepower Impeller	V40-457	\$ 80.85
	3 Horsepower Impeller	V40-458	\$ 89.85
9	1/3-3 Horsepower Brass Adapter	V40-460	\$208.50
10	Brass Pump Shaft w/O-Ring Groove	V30-449	\$ 38.85
Not Shown	Bolt & Drain Plug Kit	V40-482	\$ 37.50

MARTIN 500 SERIES 3-10 HORSEPOWER BRASS PUMP

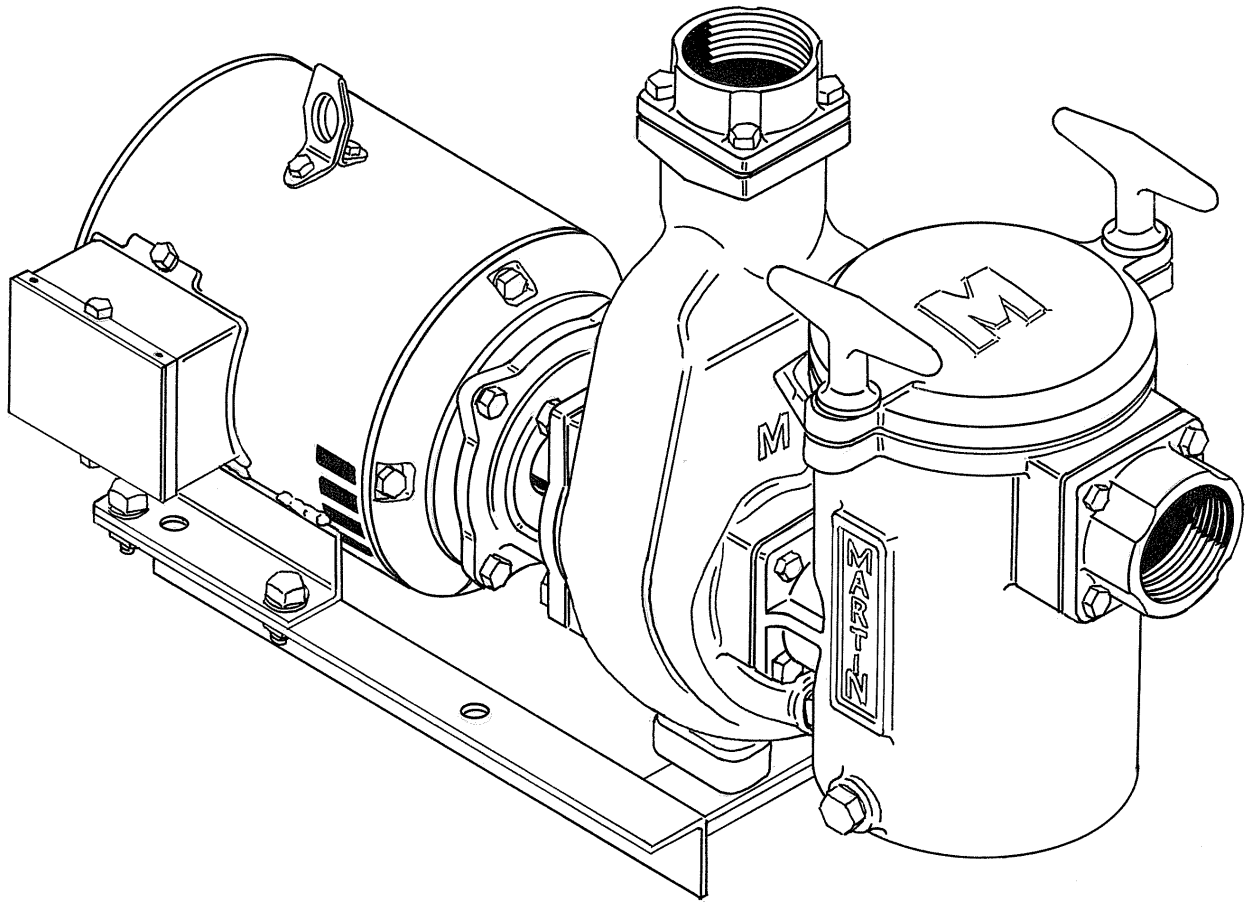

COMPLETE PUMP & MOTOR

Val-Pak Part No.	Description	List Price
V40-535	3 Horsepower Pump & Motor, 60Hz, 1-Phase 8" Trap	\$3840.00
V40-536	3 Horsepower Pump & Motor, 60Hz, 3-Phase 8" Trap	\$3405.00
V40-537	5 Horsepower Pump & Motor, 60Hz, 1-Phase 8" Trap	\$3930.00
V40-538	5 Horsepower Pump & Motor, 50/60Hz, 3-Phase 8" Trap	\$3585.00
V40-539	7½ Horsepower Pump & Motor, 50/60Hz, 3-Phase 8" Trap	\$4050.00
V40-540	10 Horsepower Pump & Motor, 50/60Hz, 3-Phase 8" Trap	\$5085.00

**All 500 Series pumps are equipped with 3-inch flanged inlet & outlet ports
and come with Stainless Steel basket.**

Viton Pump Seal available on request at additional cost.

MARTIN 500 SERIES 3-10 HP BRASS PUMP EXPLODED VIEW

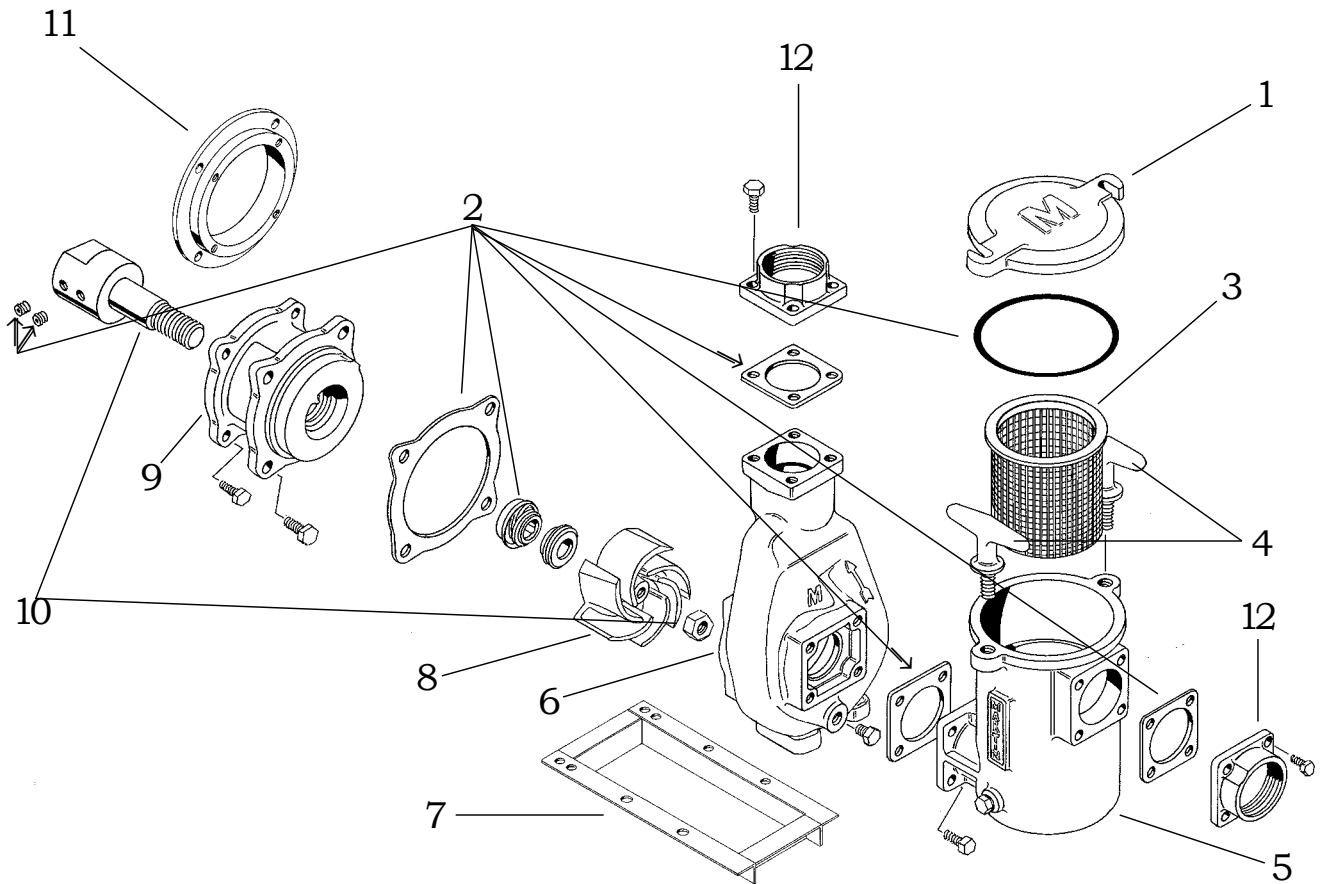

KEY NO.	PART DESCRIPTION	VAL-PAK PART NO.	LIST PRICE
1	8" Brass Pump Lid	V40-573	\$ 186.00
2	Parts Kit (incl. Seal, Gaskets, O-Rings & Set Screws)	V40-576	\$ 120.00
3	8" Pump Basket	V40-574	\$ 142.50
4	Tee Handle, Bronze w/S.S. Stud	V40-575	\$ 22.50
5	8" Brass Trap	V40-572	\$1320.00
6	Brass Volute	V40-570	\$1080.00
7	Angle Iron Base for 3, 5 & 7½ HP Pump	V40-556	\$ 91.80
	Angle Iron Base for 10 HP Pump	V40-557	\$ 106.80
8	3 Horsepower Impeller	V40-562	\$ 345.00
	5 Horsepower Impeller	V40-563	\$ 405.00
	7½ Horsepower Impeller	V40-564	\$ 450.00
	10 Horsepower Impeller	V40-565	\$ 630.00
9	3-10 Horsepower Brass Adapter	V40-561	\$ 405.00
10	Brass Pump Shaft w/Nut & Setscrews	V40-559	\$ 240.00
11	Motor Adapter Ring (10 HP only)	V40-558	\$ 357.00
12	Brass Flange 3" NPT	V40-571	\$ 135.00
	Bolt & Drain Plug Kit (inc. 20 Bolts + 2 Brass Plugs)	V40-555	\$ 45.00

PAC-FAB PUMP PARTS



CHALLENGER PUMP LID, O-RING

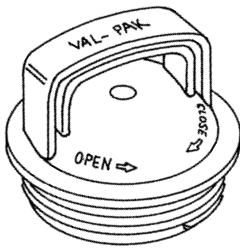

Val-Pak Part No.	Description	OEM Part No.	List Price
V36-190	Challenger Pump Lid	355301	\$ 36.75
V36-191	Challenger Lid O-ring (12/Bag)	350013	\$ 1.24

CHALLENGER PUMP BASKET

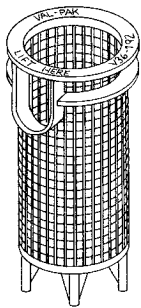

Val-Pak Part No.	Description	OEM Part No.	List Price
V36-192	Challenger Pump Basket (12/Box)	355318	\$ 22.50

HYDRO BRACKET

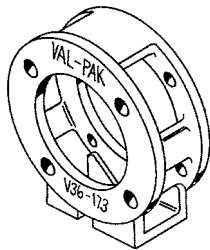

Val-Pak Part No.	Description	List Price
V36-173	Hydro Bracket, Cast Iron O/S	\$180.00

SEAL PLATE

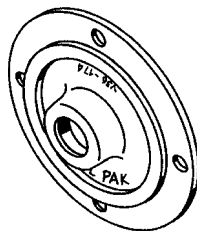

Val-Pak Part No.	Description	List Price
V36-174	Brass Seal Plate	\$135.00

PUMP SHAFT, SET SCREW

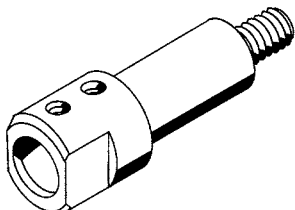

Val-Pak Part No.	Description	OEM Part No.	List Price
V36-115	Pump Shaft (5/Bag)	35-3750	\$ 19.50
V40-401	1/4 X 20 Set Screw S.S. (100/Bag)		\$.93

PAC-FAB FILTER PARTS

PISTON, CAP & HANDLE

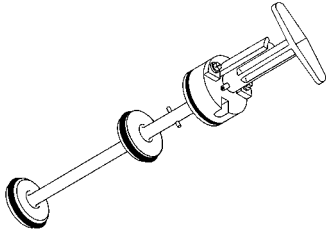

Val-Pak Part No.	Description	OEM Part No.	List Price
V36-177	Piston, Cap & Handle, 2" (Brass)	27-3240/3241	\$138.00

PISTON & SHAFT — O/S

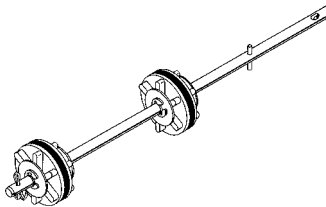

Val-Pak Part No.	Description	List Price
V36-100	Piston & Shaft, 2" - 16½", O/S for Brass Body	\$142.50

PISTON HALF REPLACEMENT KIT

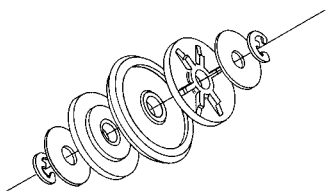

Val-Pak Part No.	Description	OEM Part No.	List Price
V36-178	Piston Half Replacement Kit, 2"	27-3028	\$ 27.00

TEE HANDLE

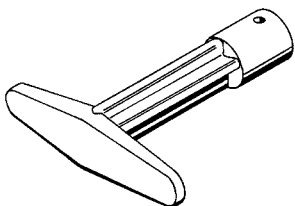

Val-Pak Part No.	Description	OEM Part No.	List Price
V36-179	Tee Handle, 3/8" Shaft	27-3065	\$ 18.75
V36-180	Tee Handle, 1/2" Shaft		\$ 18.75
V36-181	Tee Handle, 5/8" Shaft	27-3089	\$ 18.75

PAC-FAB

FILTER PARTS (Continued)

POSITION BRACKET

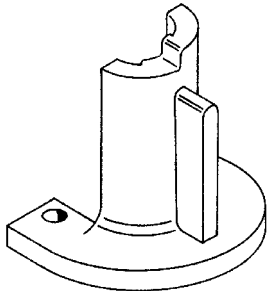

**Val-Pak
Part No.**
V36-184

Description
Position Bracket

**OEM
Part No.**
27-3064

**List
Price**
\$ 21.00

PISTON O-RING SET

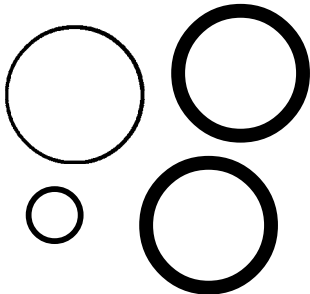

**Val-Pak
Part No.**
V36-185
V36-186

Description
Piston O-Ring Set 2", Brass New Style (25/Bag) \$ 3.36
Piston O-Ring Set 2", Plastic New Style (25/Bag) \$ 3.36

**List
Price**
\$ 3.36
\$ 3.36

PISTON CAP

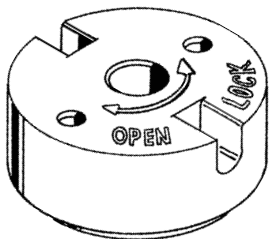

**Val-Pak
Part No.**
V36-182
V36-183

Description
PVC Piston Cap 2", Old Style (3/8" Shaft)
PVC Piston Cap 2" (1/2" Brass Shaft)

**OEM
Part No.**
27-3050

**List
Price**
\$ 26.54
\$ 26.54

PISTON SEAL

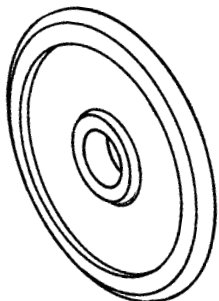

**Val-Pak
Part No.**
V36-110

Description
Piston Seal, 2" (25/Bag)

**OEM
Part No.**
27-3059

**List
Price**
\$ 2.97

PAC-FAB FILTER PARTS (Continued)

E-CLIP



Val-Pak Part No.	Description	OEM Part No.	List Price
V36-120	E-Clip, Stainless Steel (100/Bag)	27-3057	\$ 1.42

AIR RELIEF VALVE

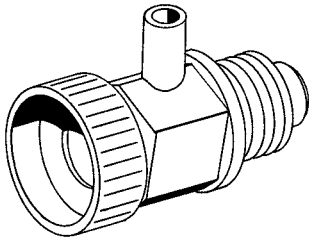

Val-Pak Part No.	Description	OEM Part No.	List Price
V38-115	Celcon Air Relief Valve 1/4" (50/Bag)	07-5207	\$ 9.45
V38-156	Repl. Valve Stem O-Ring (100/Bag)		\$.42

NAUTILUS CENTER ROD



Val-Pak Part No.	Description	OEM Part No.	List Price
V36-124	Rod, 15½" Manifold Retainer NS 24	19-2182	\$ 32.85
V36-136	Rod, 21½" Manifold Retainer NS 36	19-2183	\$ 39.30
V36-148	Rod, 27½" Manifold Retainer NS 48	19-2184	\$ 47.25
V36-160	Rod, 33½" Manifold Retainer NS 60	19-2185	\$ 57.00
V36-172	Rod, 39½" Manifold Retainer NS 72	19-5002	\$ 61.95

POOL SWEEP PARTS

A-40 GASKET

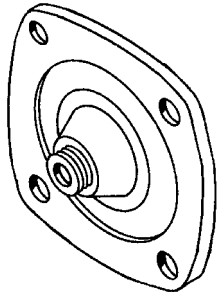

Val-Pak Part No.	Description	OEM Part No.	List Price
V32-604	A-40 Gasket	AXA40	\$ 25.50

IMPELLER

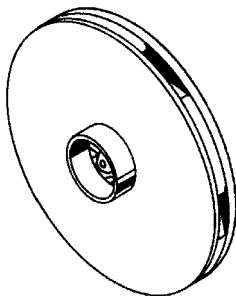

Val-Pak Part No.	Description	OEM Part No.	List Price
V32-612	A-02L Impeller 5 ⁷ / ₈ "	AXA02L	\$ 25.50

B-5 HOSE, HOSE WASHER

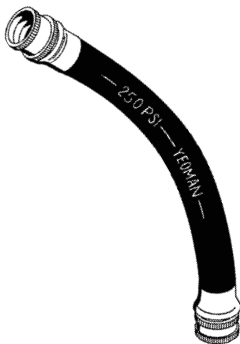

Val-Pak Part No.	Description	OEM Part No.	List Price
V32-606	B-5 Hose w/ Washer (50/Box)	AXB05	\$ 19.80
V32-607	D-10 Hose Washer (50/Bag)	AXD10P	\$.71

SADDLE TEE

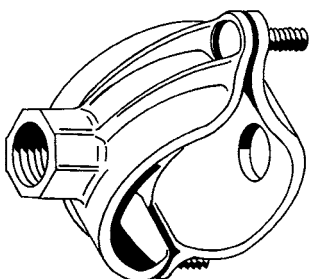

Val-Pak Part No.	Description	List Price
V32-613	K-17 — 1" X 3/4 for 1 1/4" O/D Copper	\$ 38.25
V32-614	K-18 — 1 1/4" X 3/4 for 1 1/2" O/D Copper	\$ 38.25
V32-615	K-20 — 1 1/2" X 3/4 for 2" O/D Copper	\$ 39.75
V32-616	K-31 — 1 1/2" X 3/4 for 1 1/2" O/D PVC	\$ 40.50
V32-617	K-32 — 2" X 3/4 for 2" O/D PVC	\$ 42.00

PREMIER PUMP PARTS

BRASS IMPELLER



Val-Pak Part No.	Description	OEM Part No.	List Price
V40-452	1/3 Horsepower Impeller		\$ 89.85
V40-453	1/2 Horsepower Impeller	31-380	\$ 80.85
V40-454	3/4 Horsepower Impeller	31-381	\$ 80.85
V40-455	1 Horsepower Impeller	31-382	\$ 80.85
V40-456	1½ Horsepower Impeller	31-383	\$ 80.85
V40-457	2 Horsepower Impeller	31-384	\$ 80.85
V40-458	3 Horsepower Impeller		\$ 89.85

IMPELLER WRENCH

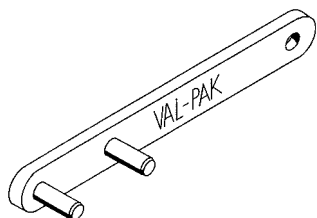

Val-Pak Part No.	Description	List Price
V40-469	Impeller Wrench	\$ 47.85

BRASS BRACKET

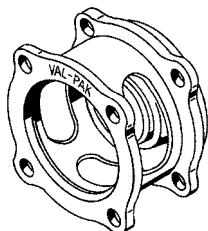

Val-Pak Part No.	Description	OEM Part No.	List Price
V40-460	1/2-2 Horsepower Bracket (w/out Foot)	31-096	\$208.80

H & F GASKET, PUMP LID O-RING

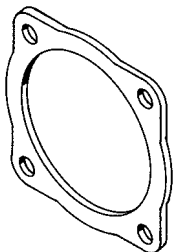

Val-Pak Part No.	Description	OEM Part No.	List Price
V40-115	H & F Gasket (12/Bag)	G44	\$ 2.10
V40-117	Pump Lid O-Ring, 5" (12/Bag)	080	\$ 2.83

POT HANDLE

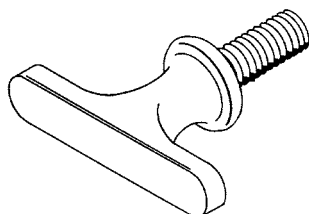

Val-Pak Part No.	Description	OEM Part No.	List Price
V40-468	Pot Handle, S.S. Stud	31-622	\$ 21.00

PREMIER PUMP PARTS (Continued)

5" CLEAR LID, O-RING

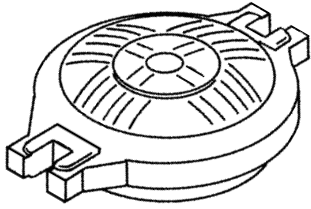

Val-Pak Part No.	Description	OEM Part No.	List Price
V31-452	Clear Lid, 5"	31-484	\$ 49.65
V40-117	Pump Lid O-Ring, 5" (12/Bag)	080	\$ 2.83

5" BRASS LID

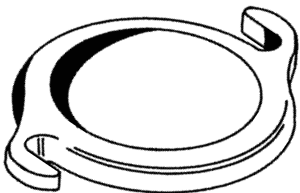

Val-Pak Part No.	Description	OEM Part No.	List Price
V40-463	Brass Lid, 5"	31-482	\$ 71.10

6" CLEAR LID

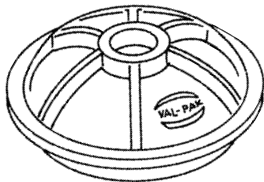

Val-Pak Part No.	Description	OEM Part No.	List Price
V31-451	Clear Lid, 6"	33-488	\$ 53.34

4" BRASS LID

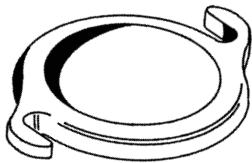

Val-Pak Part No.	Description	List Price
V31-464	Brass Lid, 4"	\$ 65.10

455 PUMP SHAFT, SET SCREW

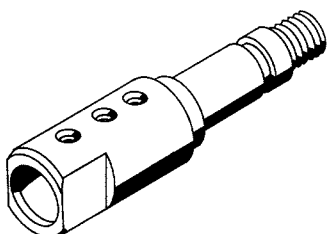

Val-Pak Part No.	Description	OEM Part No.	List Price
V30-449	Pump Shaft (w/O-Ring Groove (5/Bag)	31-814	\$ 38.85
V40-401	1/4 X 20 Set Screw S.S. (100/Bag)	31-812	\$.93

PREMIER PUMP PARTS (Continued)

658 PUMP SHAFT

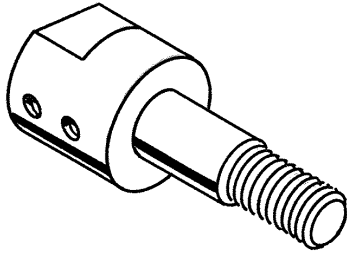

Val-Pak Part No.	Description	OEM Part No.	List Price
V40-560	Premier Pump Shaft w/Nut (5, 7½ & 10 Horsepower)	39-862	\$240.00
V40-580	Premier Pump Shaft w/Nut (3 Horsepower, 3-Phase)	39-861	\$240.00

658 BRASS IMPELLER

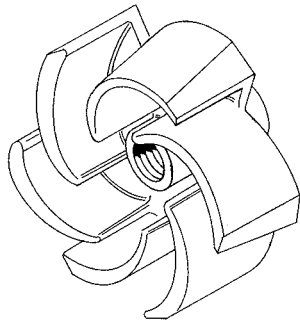

Val-Pak Part No.	Description	OEM Part No.	List Price
V40-566	3-Horsepower Brass Impeller	39-879	\$345.00
V40-567	5-Horsepower Brass Impeller	39-880	\$405.00
V40-568	7½-Horsepower Brass Impeller	39-881	\$450.00
V40-569	10-Horsepower Brass Impeller	39-882	\$630.00

658 BRASS ADAPTER

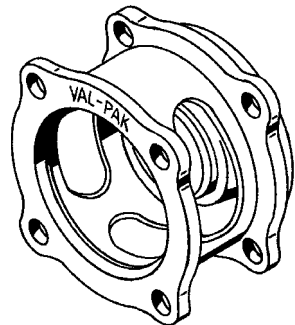

Val-Pak Part No.	Description	OEM Part No.	List Price
V40-561P	Brass Adapter, 658 Series	35-109	\$405.00

658 PUMP BASKET

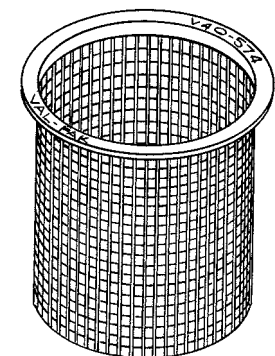

Val-Pak Part No.	Description	OEM Part No.	List Price
V40-574	8" Stainless Steel Pump Basket	39-225	\$142.50

PREMIER PUMP PARTS (Continued)

BRASS VOLUTE, 455 SERIES

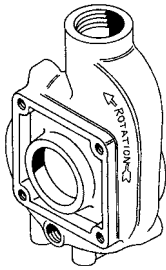

Val-Pak Part No.	Description	OEM Part No.	List Price
V31-458	Brass Volute, 455 Series	33-819	\$218.25
V31-459	Trap Gasket (12/Bag)	G99	\$ 1.53

BRASS VOLUTE, 556 SERIES

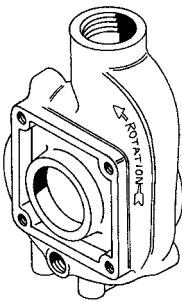

Val-Pak Part No.	Description	OEM Part No.	List Price
V31-456	Brass Volute, 556 Series	35-843	\$360.00
V31-460	556 Parts Kit		\$ 75.00

556 BRASS IMPELLER



Val-Pak Part No.	Description	OEM Part No.	List Price
V31-457	3-Horsepower Brass Impeller	31-330	\$110.85

556 BRASS ADAPTER

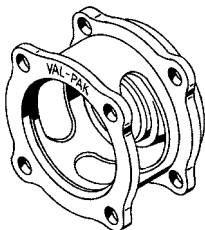

Val-Pak Part No.	Description	OEM Part No.	List Price
V40-561P	Brass Adapter, 556 Series	35-109	\$405.00

MISCELLANEOUS PREMIER PARTS

DECK ANCHOR W/WEDGE

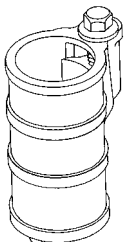

Val-Pak Part No.	Description	List Price
V40-998	Deck Anchor w/Wedge	\$ 56.85
V40-999	Anchor Wedge (10/Bag)	\$ 32.25

PREMIER FILTER PARTS

TOP HOLDING WHEEL

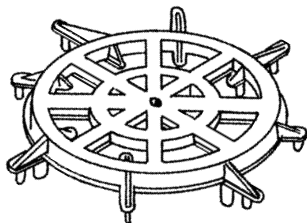

Val-Pak Part No.	Description	OEM Part No.	List Price
V20-318	Top Holding Wheel	23-780	\$ 20.70
V20-666	Wing Nut, S.S. 1/4 x 20" (25/Bag)	90-340	\$ 1.06
V20-667	Washer, S.S. 1/4" (25/Bag)	90-250	\$.64

MANIFOLD

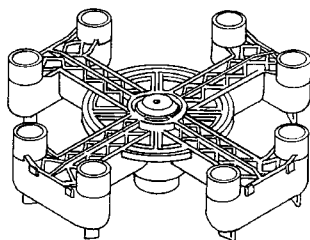

Val-Pak Part No.	Description	OEM Part No.	List Price
V30-126	Manifold, 1½"	23-791	\$ 84.30
V30-127	Manifold, 2"	23-792	\$ 84.30

CENTER ROD

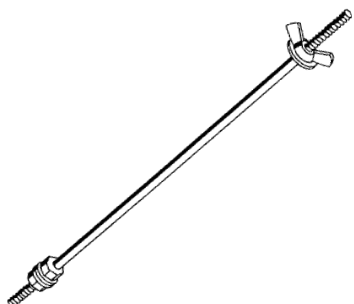

Val-Pak Part No.	Description	OEM Part No.	List Price
V30-444	PA Brass Center Rod, 24 sq. ft.	23-876	\$ 27.00
V30-445	PA Brass Center Rod, 36 sq. ft.	23-877	\$ 27.00
V30-446	PA Brass Center Rod, 48 sq. ft.	23-878	\$ 27.00
V30-447	PA Brass Center Rod, 60 sq. ft.	23-879	\$ 33.00
V30-448	PA Brass Center Rod, 72 sq. ft.	23-880	\$ 33.00

**Call Us For Additional
Premier Replacement Parts**

PUREX PUMP PARTS

WHISPERFLO BASKET

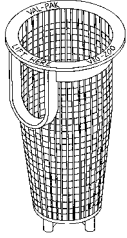

Val-Pak Part No.	Description	OEM Part No.	List Price
V20-200	Whisperflo Basket (24/Box)	070387	\$ 15.45

WHISPERFLO PUMP LID, O-RING

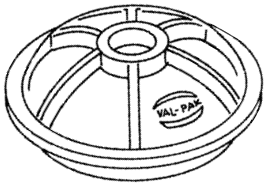

Val-Pak Part No.	Description	OEM Part No.	List Price
V20-371	Whisperflo Pump Lid (pre-98)	070795	\$ 29.85
V20-370	Whisperflo O-Ring (pre-98) (12/Bag)	071422	\$ 1.84
V20-390	Whisperflo Pump Lid N/S	357151	\$ 21.30
V20-389	Whisperflo O-Ring N/S (12/Bag)	350013	\$ 2.19

PUMP LID CLAMP

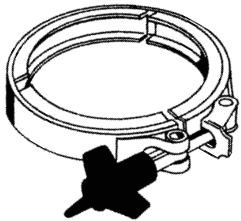

Val-Pak Part No.	Description	OEM Part No.	List Price
V20-373	Pump Lid Clamp AQ, AU & Whisperflo (pre-98)	070711	\$ 54.90

AH SERIES IMPELLER

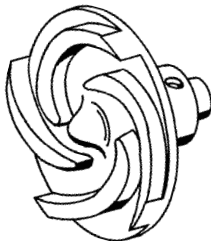

Val-Pak Part No.	Description	OEM Part No.	List Price
V20-105	1/2 Horsepower Impeller AH-2	071031	\$180.00
V20-107	3/4 Horsepower Impeller AH-3	071032	\$180.00
V20-110	1 Horsepower Impeller AH-4	071033	\$180.00
V20-115	1½ Horsepower Impeller AH-6	071034	\$180.00
V20-120	2 Horsepower Impeller AH-8	071035	\$180.00

AQ & AU SERIES IMPELLER

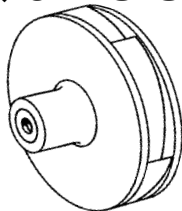

Val-Pak Part No.	Description	List Price
V20-210	1 Horsepower Impeller AQ & AU, O/S	\$ 85.50
V20-215	1½ Horsepower Impeller AQ & AU, O/S	\$ 85.50
V20-220	2 Horsepower Impeller AQ & AU, O/S	\$ 85.50

POT HANDLE

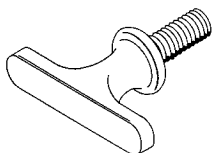

Val-Pak Part No.	Description	OEM Part No.	List Price
V40-468	A Series Pot Handle, S.S. Stud	070975	\$ 21.00

PUREX PUMP PARTS (Continued)

SEAL FLANGE O-RING

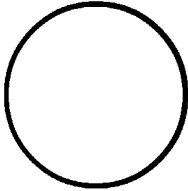

Val-Pak Part No.	Description	OEM Part No.	List Price
V20-375	A Series Seal Flange O-Ring (12/Bag)	071416	\$ 1.56
V20-309	C Series Seal Flange O-Ring	071423	\$ 3.61

L SERIES EXTENSION SHAFT

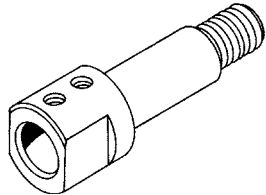

Val-Pak Part No.	Description	OEM Part No.	List Price
V20-329	L-6 Brass Extension Shaft	071748	\$ 42.46
V20-374	LK-6 Brass Ext. Shaft 3-Phase	071749	\$ 42.46

IMPELLER GAUGE

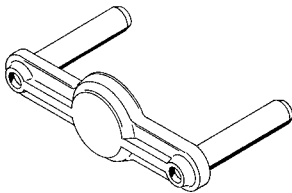

Val-Pak Part No.	Description	List Price
V20-130	Impeller Gauge	\$ 90.24

C SERIES IMPELLER

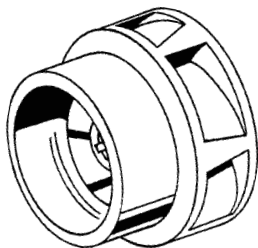

Val-Pak Part No.	Description	OEM Part No.	List Price
V20-300	5 HP Impeller CHK w/S.S. Key	073828	\$930.00
V20-301	7½ HP Impeller CHK w/S.S. Key	073829	\$930.00

AH & C SERIES POT LID O-RINGS

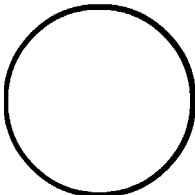

Val-Pak Part No.	Description	OEM Part No.	List Price
V20-308	AH Series Pot Lid O-Ring (12/Bag)	071421	\$ 2.62
V20-310	C Series Pot Lid O-Ring	071433	\$ 11.32

C SERIES IMPELLER WASHER, SCREW

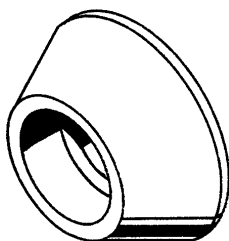

Val-Pak Part No.	Description	OEM Part No.	List Price
V20-311	C Series Impeller Washer, Brass	071048	\$ 8.90
V20-313	Impeller C-35 Lock Screw	071037	\$ 4.07

PUREX BACKWASH VALVE EXPLODED VIEW

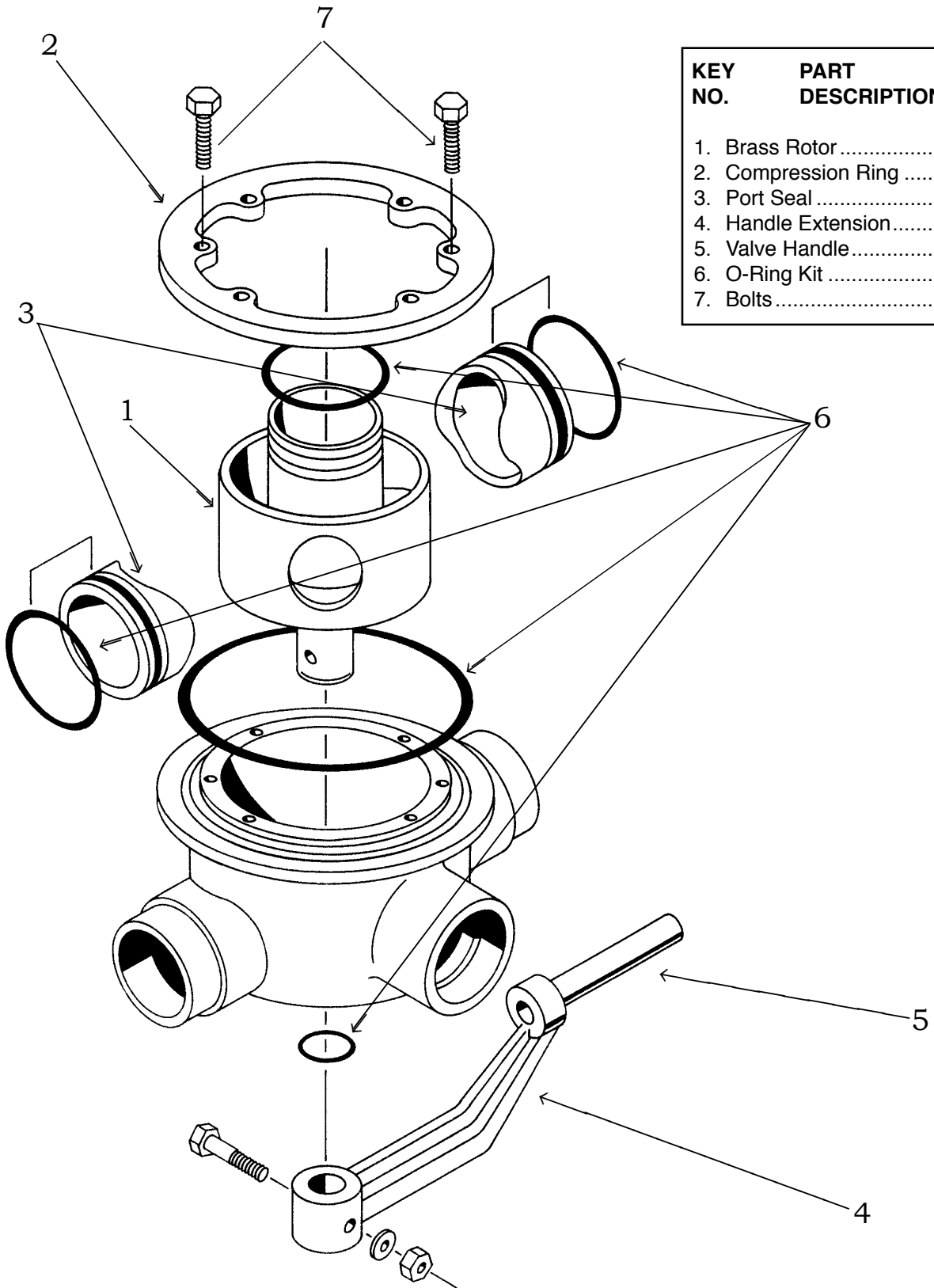

KEY NO.	PART DESCRIPTION	PART NO.
1.	Brass Rotor	V20-320
2.	Compression Ring	V20-322
3.	Port Seal	V20-321
4.	Handle Extension	V20-334
5.	Valve Handle	V20-326
6.	O-Ring Kit	V20-319
7.	Bolts	V20-323

PUREX BACKWASH VALVE PARTS

BRASS ROTOR

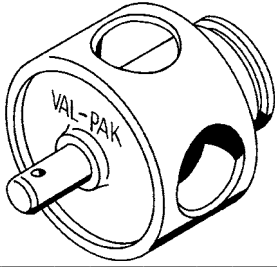

**Val-Pak
Part No.**
V20-320

Description
Brass Rotor

**OEM
Part No.**
072110

**List
Price**
\$347.85

PORT SEAL

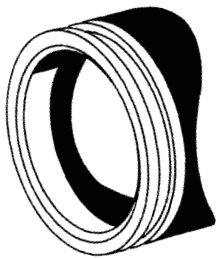

**Val-Pak
Part No.**
V20-321

Description
Port Seal

**OEM
Part No.**
070729

**List
Price**
\$ 47.70

BRASS ROTOR O-RING KIT

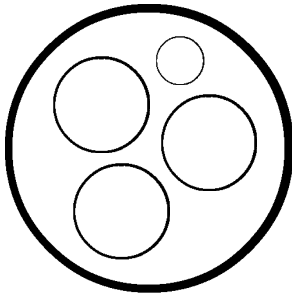

**Val-Pak
Part No.**
V20-319

Description
Brass Rotor O-Ring Kit (25/Bag)

**List
Price**
\$ 5.95

COMPRESSION RING

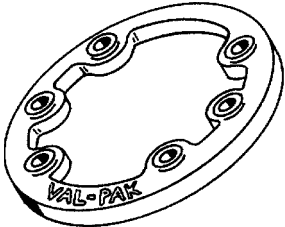

**Val-Pak
Part No.**
V20-322

Description
Compression Ring (5/Package)

**OEM
Part No.**
070731

**List
Price**
\$ 63.00

NORYL ROTOR O-RING KIT

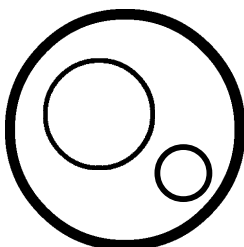

**Val-Pak
Part No.**
V20-353

Description
Noryl Rotor O-Ring Kit (25/Bag)

**List
Price**
\$ 4.85

PUREX BACKWASH VALVE PARTS (Continued)

COMPRESSION RING BOLT

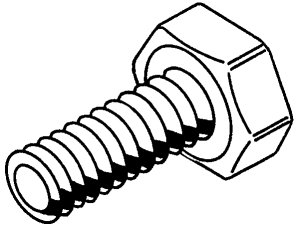

**Val-Pak
Part No.**
V20-323

Description
Compression Ring Bolt S.S. (100/Bag)

**OEM
Part No.**
074927

**List
Price**
\$.46

ROTOR VALVE HANDLE

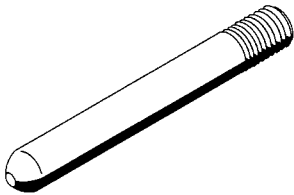

**Val-Pak
Part No.**
V20-326

Description
Brass/Noryl Rotor Valve Handle

**OEM
Part No.**
190026

**List
Price**
\$ 42.93

ROTOR VALVE HANDLE EXTENSION

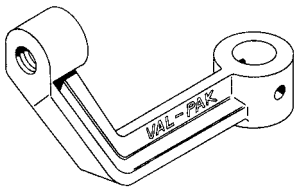

**Val-Pak
Part No.**
V20-334

Description
Brass/Noryl Rotor Valve Handle Ext.

**OEM
Part No.**
070971

**List
Price**
\$ 84.27

2" PISTON SHAFT

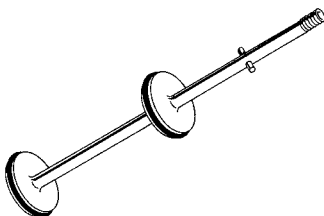

**Val-Pak
Part No.**
V20-337

Description
Piston Shaft, 2" (CHD)

**List
Price**
\$212.32

PUREX ORTEGA VALVE PARTS

BRASS ORTEGA VALVE COMPLETE

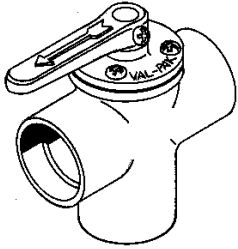

Val-Pak Part No.	Description	List Price
V20-090	Ortega Valve Complete 1½" Brass	\$378.00
V20-089	Ortega Valve Complete 2" Brass	\$399.00

BRASS DIVERTER CAP & HANDLE

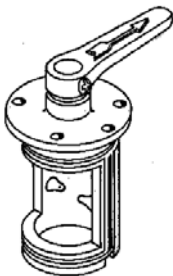

Val-Pak Part No.	Description	OEM Part No.	List Price
V20-092	Diverter Cap & Handle 1½"	072432	\$136.50
V20-091	Diverter Cap & Handle 2"	072431	\$151.50

ORTEGA SHAFT

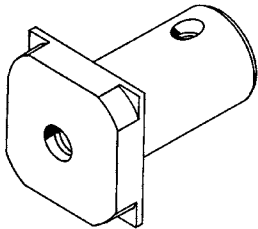

Val-Pak Part No.	Description	OEM Part No.	List Price
V20-335	Ortega Shaft for Noryl Diverter	072427	\$ 8.90

ORTEGA HANDLE, SCREW

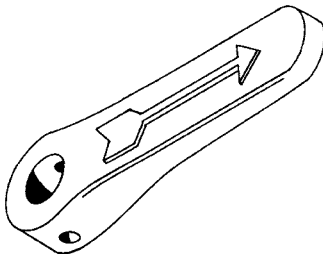

Val-Pak Part No.	Description	OEM Part No.	List Price
V20-330	Ortega Handle (Metal)	072392	\$ 18.00
V20-338	Handle Screw 8-32 x 3/8" S.S. (50/Bag)	072540	\$.32

ORTEGA O-RING SET

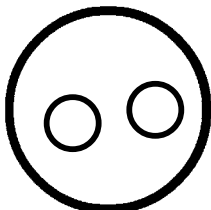

Val-Pak Part No.	Description	List Price
V20-331	Ortega Valve O-Ring Set 1½" (25/Bag)	\$ 2.62
V20-332	Ortega Valve O-Ring Set 2" (25/Bag)	\$ 2.62

PUREX RETURN FITTINGS

SPA CHECK VALVE

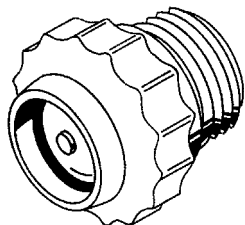

Val-Pak Part No.	Description	OEM Part No.	List Price
V20-339	Spa Check Valve 1½" MIP (White)	010646	\$ 29.85
V20-340	Spa Check Valve 1½" MIP (Black)		\$ 29.85
V20-341	Spa Check Valve 1½" MIP (Dark Gray)		\$ 29.85
V20-342	Spa Check Valve 1½" MIP (Light Gray)		\$ 29.85
V20-343	Spa Check Valve Slip (White)		\$ 32.25
V20-344	Spa Check Valve Slip (Black)		\$ 32.25
V20-345	Spa Check Valve Slip (Dark Gray)		\$ 32.25
V20-346	Spa Check Valve Slip (Light Gray)		\$ 32.25

1" SPA CHECK VALVE



Val-Pak Part No.	Description	OEM Part No.	List Price
V20-350	Spa Check Valve, 1" Slip	10647	\$ 29.85

RETURN FITTING

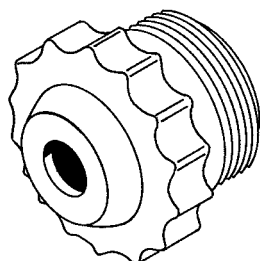

Val-Pak Part No.	Description	List Price
V20-386	Return Fitting - White 1/2"	\$ 3.45
V20-387	Return Fitting - White 3/4"	\$ 3.45
V20-388	Return Fitting - White 1"	\$ 3.45
V20-406	Return Fitting - Black 1/2"	\$ 3.45
V20-391	Return Fitting - Black 3/4"	\$ 3.45
V20-392	Return Fitting - Black 1"	\$ 3.45
V20-394	Return Fitting - Light Gray 1/2"	\$ 3.45
V20-395	Return Fitting - Light Gray 3/4"	\$ 3.45
V20-396	Return Fitting - Light Gray 1"	\$ 3.45
V20-398	Return Fitting - Dark Gray 1/2"	\$ 3.45
V20-399	Return Fitting - Dark Gray 3/4"	\$ 3.45
V20-400	Return Fitting - Dark Gray 1"	\$ 3.45

BLANK RETURN FITTING

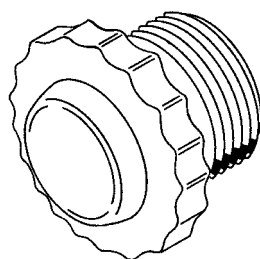

Val-Pak Part No.	Description	List Price
V20-377	Blank Return Fitting - White	\$ 4.20
V20-378	Blank Return Fitting - Black	\$ 4.20
V20-379	Blank Return Fitting - Dark Gray	\$ 4.20
V20-380	Blank Return Fitting - Light Gray	\$ 4.20

PUREX FILTER PARTS

FILTER GRID

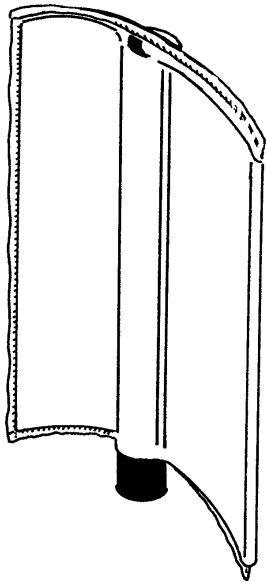

Val-Pak Part No.	Description	List Price
V20-624	2024 Commercial Filter Grid (25/Box)	\$ 25.66
V20-636	2036 Commercial Filter Grid (25/Box)	\$ 33.10
V20-648	2048 Commercial Filter Grid (25/Box)	\$ 40.70
V20-660	2060 Commercial Filter Grid (25/Box)	\$ 48.24
V20-672	2072 Commercial Filter Grid (25/Box)	\$ 54.41

Purex grids must be ordered in quantities of 100 or more. They can be assorted.

TOP HOLDING WHEEL

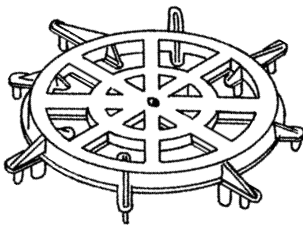

Val-Pak Part No.	Description	OEM Part No.	List Price
V20-318	Top Holding Wheel	071019	\$ 20.70
V20-666	Wing Nut, S.S. 1/4 x 20" (25/Bag)	071404	\$ 1.06
V20-667	Washer, S.S. 1/4" (25/Bag)	072173	\$.64

MANIFOLD 2000 SERIES

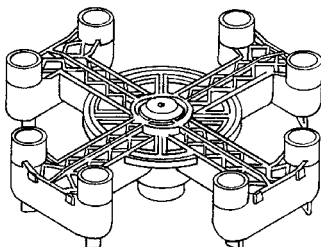

Val-Pak Part No.	Description	OEM Part No.	List Price
V20-369	Manifold 2000 Series 8-hole (12/Box)	073270	\$ 32.37

PUREX FILTER PARTS (Continued)

RED LINE TANK O-RING

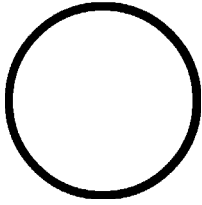

Val-Pak Part No.	Description	List Price
V20-365	2000 Series Red Line Tank O-Ring (25/Bag)	\$ 20.52

AIR RELIEF VALVE

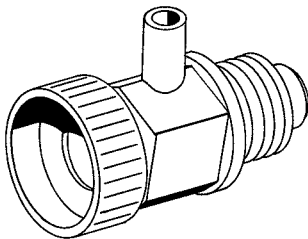

Val-Pak Part No.	Description	OEM Part No.	List Price
V38-115	Celcon Air Relief Valve 1/4" (50/Bag)	075207	\$ 9.45
V38-156	Repl. Valve Stem O-Ring (100/Bag)		\$.42

TANK BAND ADJUSTING SCREW

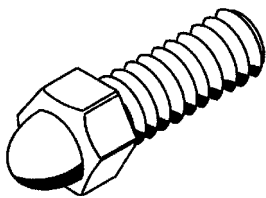

Val-Pak Part No.	Description	List Price
V20-325	Tank Band Adjusting Screw (5/Bag)	\$ 7.08

PRESSURE GAUGE

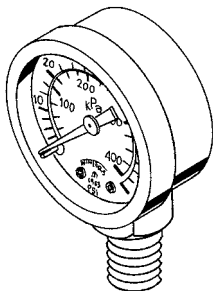

Val-Pak Part No.	Description	List Price
V34-161	1/4" Pressure Gauge 0-60 PSI	\$ 9.20

PUREX CENTER RODS

800 SERIES SM GREEN

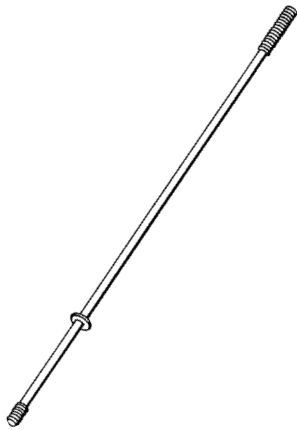

Val-Pak Part No.	Description	OEM Part No.	List Price
V20-812	SM-812 15½" Green	N/A	\$ 30.00
V20-816	SM-816 18½" Green	073666	\$ 30.00
V20-820	SM-820 21½" Green	073667	\$ 30.00
V20-830	SM-830 30½" Green	073668	\$ 30.00
V20-840	SM-840 39½" Green	N/A	\$ 45.00

2000 SERIES SM RED

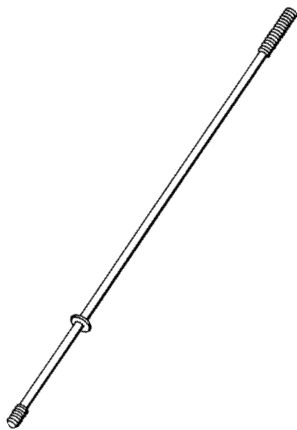

Val-Pak Part No.	Description	OEM Part No.	List Price
V20-224	SM-2024 21" Red	072885	\$ 24.75
V20-236	SM-2036 27" Red	072871	\$ 24.75
V20-248	SM-2048 33" Red	072872	\$ 24.75
V20-260	SM-2060 39" Red	072873	\$ 27.00
V20-272	SM-2072 45" Red	072874	\$ 28.50

2000 SERIES SMBW BLUE

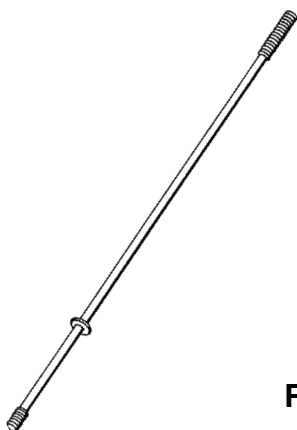

Val-Pak Part No.	Description	OEM Part No.	List Price
V20-324	SMBW-2024-21" Brass Rotor Blue	073663	\$ 24.75
V20-336	SMBW-2036-27" Brass Rotor Blue	073662	\$ 24.75
V20-348	SMBW-2048-33" Brass Rotor Blue	073661	\$ 24.75
V20-360	SMBW-2060-39" Brass Rotor Blue	073660	\$ 27.00
V20-372	SMBW-2072-45" Brass Rotor Blue	073659	\$ 28.50

Rods must be ordered in quantities of 5 or more.

PUREX CENTER RODS (Continued)

2000, 4000 SERIES SMBW WHITE

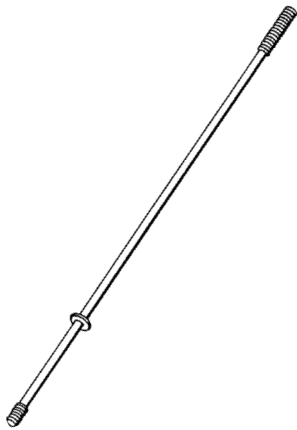

Val-Pak Part No.	Description	OEM Part No.	List Price
V20-424	SMBW-2024/4024-21" Noryl Rotor White	072870	\$ 24.75
V20-436	SMBW-2036/4036-27" Noryl Rotor White	072869	\$ 24.75
V20-448	SMBW-2048/4048-33" Noryl Rotor White	072868	\$ 24.75
V20-460	SMBW-2060-39" Noryl Rotor White	072867	\$ 27.00
V20-472	SMBW-2072-45" Noryl Rotor White	072866	\$ 28.50

Rods must be ordered in quantities of 5 or more.

4000 SERIES SM RED

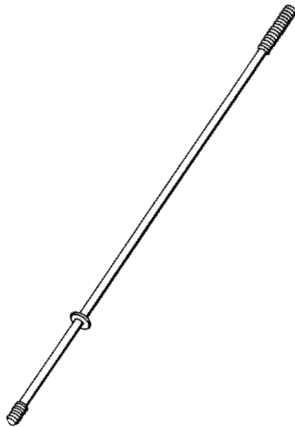

Val-Pak Part No.	Description	OEM Part No.	List Price
V20-524	SM-4024-21" Red	072875	\$ 24.75
V20-536	SM-4036-27" Red	072876	\$ 24.75
V20-548	SM-4048-33" Red	072877	\$ 24.75

CFM & CFW SERIES

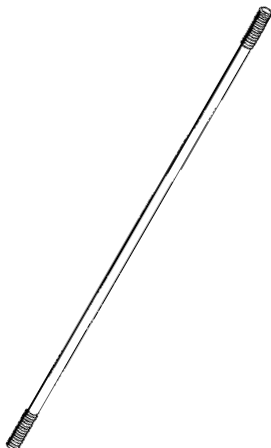

Val-Pak Part No.	Description	OEM Part No.	List Price
CFM SERIES			
V20-544	CFM-120 (18 ⁷ / ₈ "	070666	\$ 23.25
V20-546	CFM-180/240 (27 ¹ / ₄ "	075147	\$ 23.25
V20-547	CFM-315 (33 ¹ / ₂ "	070241	\$ 27.00
CFW SERIES			
V20-327	CFW-100 (17"	070668	\$ 27.00
V20-545	CFW-120 (13"	070664	\$ 27.00
V20-328	CFW-150 (22 ³ / ₄ "	070665	\$ 27.00

STA-RITE PUMP PARTS

6" TRAP COVER, O-RING

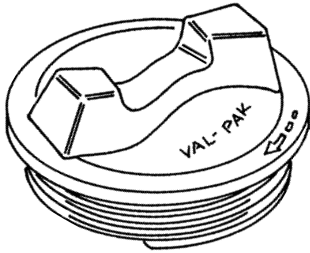

Val-Pak Part No.	Description	OEM Part No.	List Price
V26-363	Trap Cover	16920-0011	\$ 41.85
V26-366	Trap Cover O-Ring (12/Bag)	16920-0012	\$ 2.55

MAX-E-GLAS/ DURA-GLAS TRAP COVER, O-RING

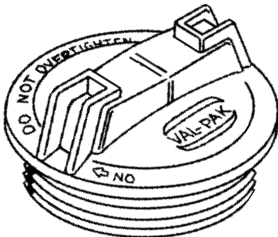

Val-Pak Part No.	Description	OEM Part No.	List Price
V26-361	Trap Cover, 5"	C3-139P1	\$ 34.50
V26-360	Trap Cover O-Ring, 5" (12/Bag)	U9-229	\$ 2.55

MAX-E-GLAS II / DURA-GLAS II TRAP COVER, O-RING

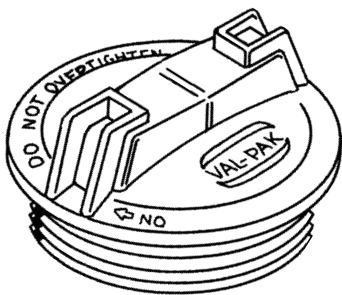

Val-Pak Part No.	Description	OEM Part No.	List Price
V26-362	Trap Cover	C3-185P	\$ 35.85
V26-365	Trap Cover O-Ring (12/Bag)	U9-375	\$ 2.69

DURA-GLAS IMPELLER

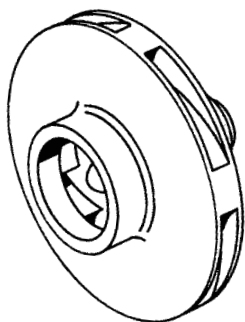

Val-Pak Part No.	Description	OEM Part No.	List Price
V26-375	1/2 Horsepower Impeller	C105-92PS	\$ 42.60
V26-376	3/4 Horsepower Impeller	C105-138PEBA	\$ 42.60
V26-377	1 Horsepower Impeller	C105-137PEBA	\$ 45.60
V26-378	1½ Horsepower Impeller	C105-137PDBA	\$ 57.00
V26-379	2 Horsepower Impeller	C105-137PDA	\$ 57.00

STA-RITE PUMP PARTS (Continued)

MAX-E-PRO / DURA-GLAS II PUMP BASKET

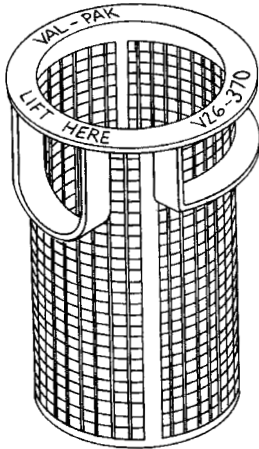

Val-Pak Part No. V26-370	Description Pump Basket (16/Box)	OEM Part No. C8-58P	List Price \$ 13.47
--	--	-----------------------------------	-----------------------------------

DURA-GLAS SEAL PLATE O-RING

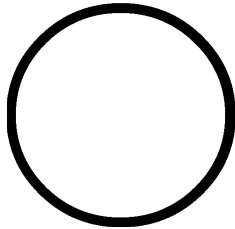

Val-Pak Part No. V26-354	Description Seal Plate O-Ring (12/Bag)	OEM Part No. U9-228A	List Price \$ 4.18
--	--	------------------------------------	----------------------------------

MAX-E-GLAS / DURA-GLAS GASKET

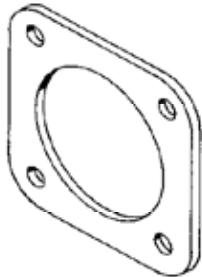

Val-Pak Part No. V26-359	Description Trap Gasket — Rubber (12/Bag)	OEM Part No. C20-123	List Price \$ 2.62
--	---	------------------------------------	----------------------------------

DIFFUSER, O-RING

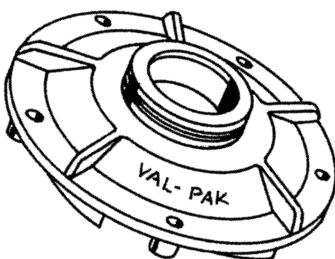

Val-Pak Part No. V26-367	Description Diffuser 3/4-2 HP (Full Rated)	OEM Part No. C1-200PA	List Price \$ 18.30
V26-368	Diffuser O-Ring(12/Bag)	U9-226	\$.96

STA-RITE PUMP PARTS (Continued)

IMPELLER LOCKING SCREW

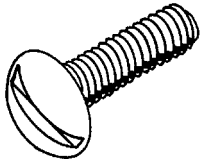

**Val-Pak
Part No.**
V26-352

Description
Impeller Locking Screw (10/Bag)

**OEM
Part No.**
C30-12

**List
Price**
\$ 4.32

DURA-GLAS CLAMP

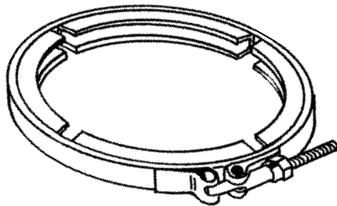

**Val-Pak
Part No.**
V26-351

Description
Dura-Glas Clamp

**OEM
Part No.**
C19-37A

**List
Price**
\$ 64.35

DURA-GLAS CLAMP KNOB

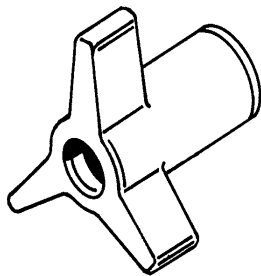

**Val-Pak
Part No.**
V26-358

Description
Dura-Glas Clamp Knob

**OEM
Part No.**
WC36-22

**List
Price**
\$ 7.61

PUMP SHAFT, SET SCREW

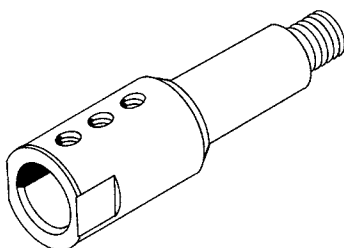

**Val-Pak
Part No.**
V40-116
V40-401

Description
Pump Shaft (w/out O-Ring Groove) (10/Bag)
1/4 X 20 Set Screw S.S. (100/Bag)

**OEM
Part No.**
99730000

**List
Price**
\$ 19.50
\$.93

STA-RITE PUMP PARTS (Continued)

BRASS IMPELLER



Val-Pak Part No.	Description	OEM Part No.	List Price
V40-452	1/3 Horsepower Impeller		\$ 89.85
V40-453	1/2 Horsepower Impeller	CS-164D	\$ 80.85
V40-454	3/4 Horsepower Impeller	CS-166D	\$ 80.85
V40-455	1 Horsepower Impeller	CS-183D	\$ 80.85
V40-456	1½ Horsepower Impeller	CS-181D	\$ 80.85
V40-457	2 Horsepower Impeller	CS-182D	\$ 80.85
V40-458	3 Horsepower Impeller		\$ 89.85

BRASS BRACKET

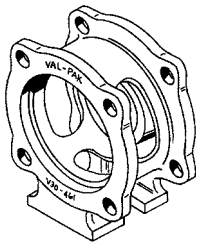

Val-Pak Part No.	Description	OEM Part No.	List Price
V30-461	1/3-3 Horsepower Bracket (w/Foot)	C2-57D	\$218.25

TRAP HANDLE

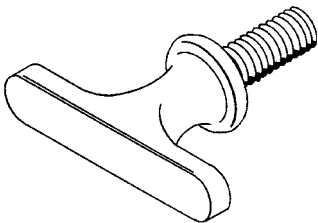

Val-Pak Part No.	Description	OEM Part No.	List Price
V40-468	Trap Handle	C154-18D	\$ 21.00

CAST IRON ADAPTER

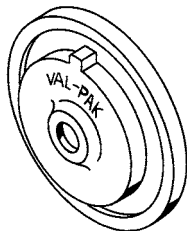

Val-Pak Part No.	Description	OEM Part No.	List Price
V26-334	C3-67 Cast Iron Adapter	C3-67	\$ 75.00

COPPER LINER

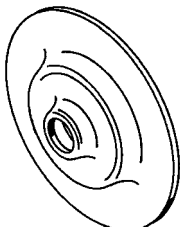

Val-Pak Part No.	Description	OEM Part No.	List Price
V26-333	C3-66D Copper Liner F Series	C3-66D	\$ 69.00

STA-RITE FILTER PARTS

AIR RELIEF VALVE

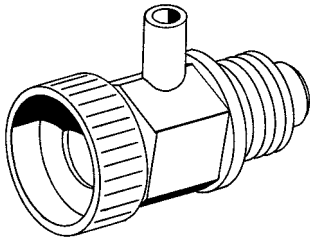

Val-Pak Part No.	Description	List Price
V38-115	Celcon Air Relief Valve 1/4" (50/Bag)	\$ 9.45
V38-156	Replacement Valve Stem O-Ring (100/Bag)	\$.42

THROUGH ROD



Val-Pak Part No.	Description	OEM Part No.	List Price
V26-335	24 ⁷ / ₈ " S.S. 1/4" Through Rod	WC30-39	\$ 27.00
V26-350	36" S.S. 1/4" X 20 All Thread Rod		\$ 28.50

PISTON, CAP & HANDLE

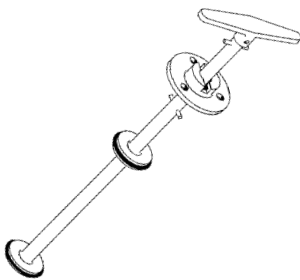

Val-Pak Part No.	Description	OEM Part No.	List Price
V26-347	Piston, Cap & Handle 1 1/2" O/S	WC158-3	\$330.00
V26-357	Piston, Cap & Handle 1 1/2" N/S	WC158-5	\$330.00
V26-349	Piston, Cap & Handle 2"	WC158-6	\$390.00

PISTON, CAP & HANDLE, 3-PUCK

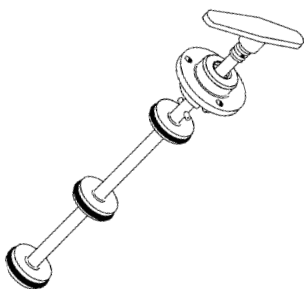

Val-Pak Part No.	Description	OEM Part No.	List Price
V26-348	Piston, Cap & Handle 1 1/2" 3-Puck	WC158-12	\$420.00

STA-RITE FILTER PARTS (Continued)

DUETTA PISTON SHAFT

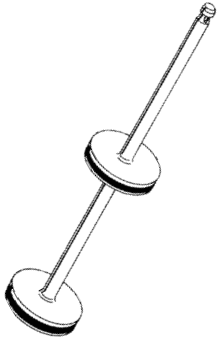

Val-Pak Part No. V26-500	Description Piston Shaft 2" - 15 ³ / ₄ " in Length Brass	List Price \$120.00
--	--	-----------------------------------

DUETTA PISTON CAP & HANDLE

**Available
Spring 2007**

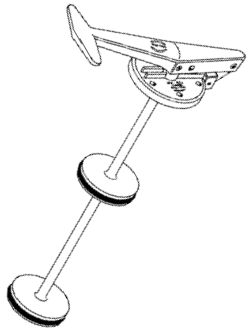

Val-Pak Part No. V26-501	Description Piston Cap & Handle Brass	List Price \$ 146.85
--	---	------------------------------------

PISTON O-RING SET

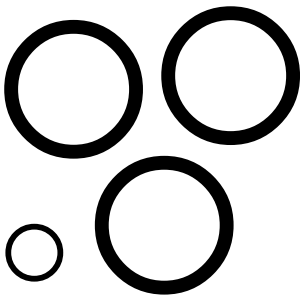

Val-Pak Part No. V26-339	Description Piston O-Ring Set, 1 ¹ / ₂ " O/S (25/Bag)	List Price \$ 3.36
V26-340	Piston O-Ring Set, 1 ¹ / ₂ " 3-Puck (25/Bag)	\$ 3.36
V26-341	Piston O-Ring Set, 2" (25/Bag)	\$ 3.36

TANK CLAMP

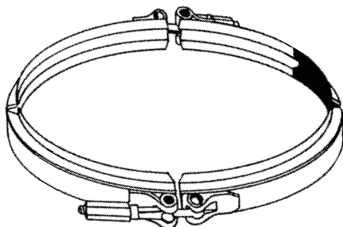

Val-Pak Part No. V26-355	Description Tank Clamp, 18" (2-Piece)	OEM Part No. WC219-13	List Price \$126.48
--	---	-------------------------------------	-----------------------------------

SWIMQUIP PUMP PARTS

PUMP SHAFT, SET SCREW

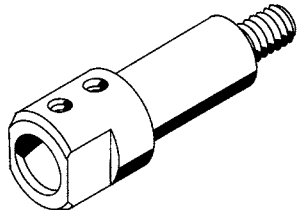

Val-Pak Part No.	Description	OEM Part No.	List Price
V22-112	Pump Shaft (5/Bag)	16800-29	\$ 19.50
V40-401	1/4 X 20 Set Screw S.S. (100/Bag)		\$.93

SWIMQUIP FILTER PARTS

RETAINING ROD

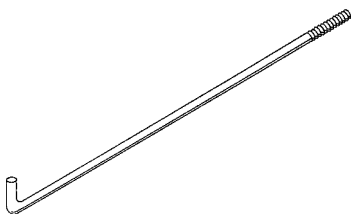

Val-Pak Part No.	Description	OEM Part No.	List Price
V22-111	4D Element Retaining Rod S.S.	23900-0039	\$ 22.35

FILTER CLAMP

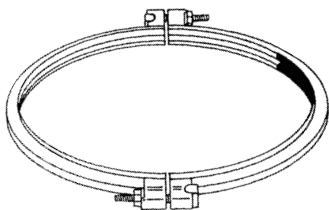

Val-Pak Part No.	Description	OEM Part No.	List Price
V22-123	DES-36 Filter Clamp	24700-0594	\$195.00
V22-124	DES-51 Filter Clamp	24700-0614	\$198.00

PISTON & SHAFT W/ O-RINGS

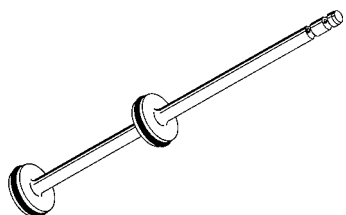

Val-Pak Part No.	Description	OEM Part No.	List Price
V22-113	Piston & Shaft 1½"-15¼" in Length	14819-11	\$105.00
V22-114	Piston & Shaft 2"-15¼" in Length	14823-11	\$120.00

SWIMQUIP FILTER PARTS

LEVER HANDLE

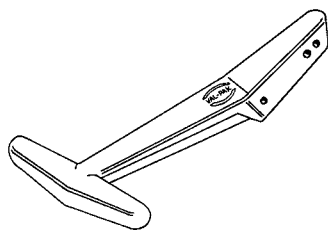

Val-Pak Part No.	Description	OEM Part No.	List Price
V22-117	Lever Handle (Brass Slide Valve)	14821-5	\$ 41.85
V22-122	Lever Handle (Plastic Slide Valve)	14930-14	\$ 61.32

PISTON O-RING SET

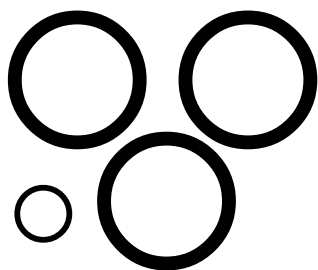

Val-Pak Part No.	Description	List Price
V22-115	Piston O-Ring Set (1½" (25/Bag)	\$ 3.36
V22-116	Piston O-Ring Set 2" (25/Bag)	\$ 3.36
V22-121	Piston O-Ring Set 2" Plastic (25/Bag)	\$ 4.00

SPRING PIN

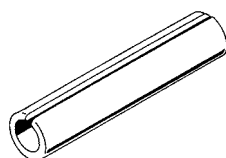

Val-Pak Part No.	Description	List Price
V22-118	Spring Pin 1/8 x 9/16" S.S. (50/Bag)	\$ 2.34
V22-119	Spring Pin 1/8 x 7/8" S.S. (50/Bag)	\$ 2.34

U-3 SKIMMER BASKET

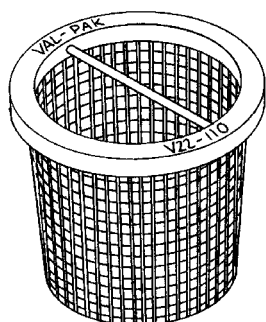

Val-Pak Part No.	Description	OEM Part No.	List Price
V22-110	U-3 Skimmer Basket (28/Box)	08650-0007	\$ 20.91
V22-110H	U-3 Skimmer Handle (10/Bag)		\$ 2.85

U-3 SKIMMER LID

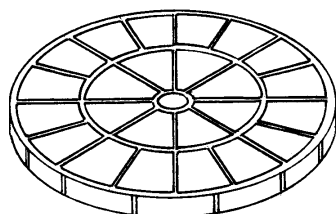

Val-Pak Part No.	Description	List Price
V22-109W	U-3 Skimmer Lid (White)	\$ 10.58
V22-109G	U-3 Skimmer Lid (Gray)	\$ 10.58
V22-109T	U-3 Skimmer Lid (Tan)	\$ 10.58
V22-109R	U-3 Skimmer Lid (Red)	\$ 10.58
V22-109GN	U-3 Skimmer Lid (Green)	\$ 10.58

SWIMRITE EQUIPMENT PARTS

7" CLEAR LID FOR S.S. POT

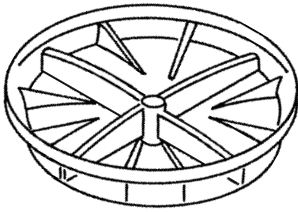

Val-Pak Part No.	Description	OEM Part No.	List Price
V30-442	Clear Lid for S.S. Pot - 7" Dia.	397048	\$ 75.00

7" LID CLAMP

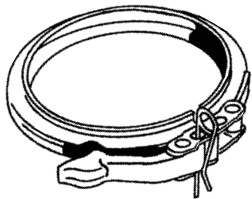

Val-Pak Part No.	Description	OEM Part No.	List Price
V30-443	Clamp for S.S. Pot, 7"		\$ 78.00

PISTON, CAP & HANDLE

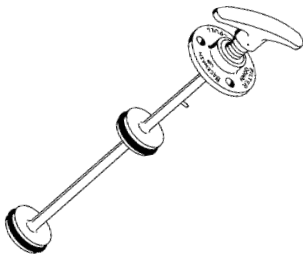

Val-Pak Part No.	Description	OEM Part No.	List Price
V30-411	Piston, Cap & Handle 1½" O/S (Short)	30-828-782	\$294.00
V30-413	Piston, Cap & Handle 1½" N/S (Long)	30-828-780	\$294.00
V30-417	Piston, Cap & Handle 2"	30-828-783	\$330.00

SATELLITE UNDERDRAIN

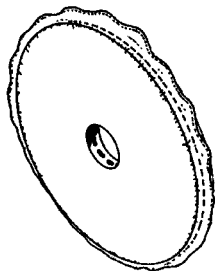

Val-Pak Part No.	Description	OEM Part No.	List Price
V30-431	Satellite Underdrain, 1½"	28-828-748	\$135.00
V30-432	Satellite Underdrain, 2"	28-828-754	\$135.00

Call Us For Additional Swimrite Replacement Parts

MISCELLANEOUS PARTS & PRODUCTS

TOOL CADDY

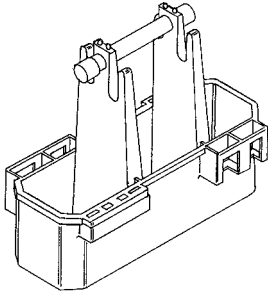

Val-Pak Part No.	Description	List Price
V50-200	Tool Caddy (25/Pallet)	\$ 88.26
V50-204	Tool Caddy (4/Box)	\$ 91.44

DOW 111

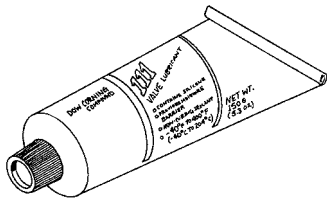

Val-Pak Part No.	Description	List Price
V40-111	Dow 111 Silicone Grease - 5.3 oz. tube (12/Box)	\$ 33.44

EZ CLOR WINTERIZING PLUG



Val-Pak Part No.	Description	List Price
V40-400	EZ Clor Winterizing Plugs (100/Bag)	\$ 1.06

SOLDER

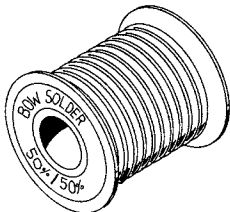

Val-Pak Part No.	Description	List Price
V42-102	1 Lb. 50/50 Solder	\$ 26.85
V42-103	1 Lb. 50/50 Solder (50/Box)	\$1257.00

ZINC BALL

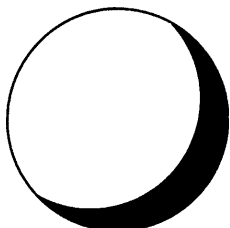

Val-Pak Part No.	Description	List Price
V50-202	Zinc Ball (25/Box)	\$ 14.88

MISCELLANEOUS PARTS & PRODUCTS (Continued)

WET INDUSTRIES 6" PUMP CLAMP

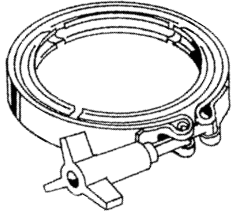

Val-Pak Part No.	Description
V65-102	Wet Industries 6" Pump Clamp, S.S.

List Price
\$ 71.55

WET INDUSTRIES 6" PUMP BASKET

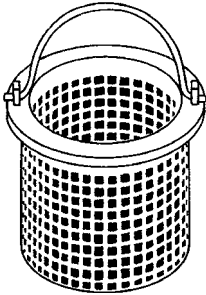

Val-Pak Part No.	Description
V65-101	Wet Industries 6" Pump Basket

List Price
\$ 21.23

WET INDUSTRIES 6" CLEAR LID

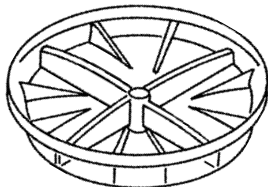

Val-Pak Part No.	Description
V65-100	Wet Industries 6" Clear Lid - 6½" Diameter
V65-103	6" Pump Lid O-Ring (12/Bag)

List Price
\$ 54.85
\$ 2.55

BRASS DECK DRAIN GRATE

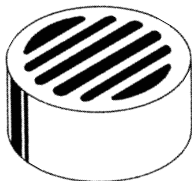

Val-Pak Part No.	Description
V65-110	3" Brass Deck Drain Grate
V65-111	4" Brass Deck Drain Grate

List Price
\$ 37.50
\$ 45.00

MISCELLANEOUS PARTS & PRODUCTS (Continued)

JACUZZI PUMP SHAFT

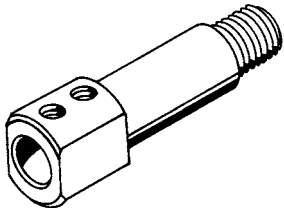

Val-Pak Part No.	Description	OEM Part No.	List Price
V45-100	Jacuzzi Pump shaft	07361009	\$ 25.50

JACUZZI PUMP BRACKET

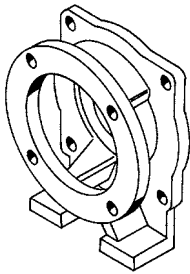

Val-Pak Part No.	Description	OEM Part No.	List Price
V45-101	Jacuzzi Pump Bracket	02077105	\$180.00

V-CLIP

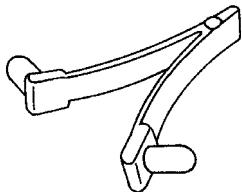

Val-Pak Part No.	Description	List Price
V50-110	Quick Change V-Clip, Black (100/Bag)	\$.46
V50-111	Quick Change V-Clip, White (100/Bag)	\$.46

MISCELLANEOUS PARTS & PRODUCTS (Continued)

INTERNAL AIR BUTTON

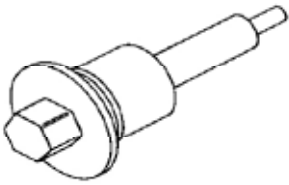

**Val-Pak
Part No.**
V50-112

Description
Len Gordon #4 Internal - White (10/Bag)

**List
Price**
\$ 17.52

SKIMMER COVER

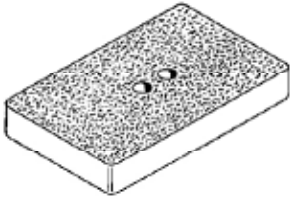

**Val-Pak
Part No.**
V50-113

Description
10" x 15" Molded Skimmer Cover (10/Box)

**List
Price**
\$ 48.75

INVERTED STRAINER BASKET

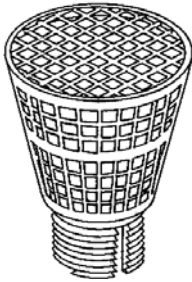

Part No.
V50-120

Description
Inverted Strainer Basket (28/Box)

Price
\$ 22.47

HANDLE GRIP

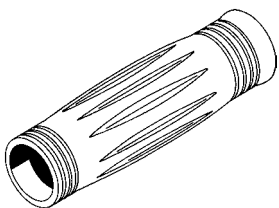

**Val-Pak
Part No.**
V50-114

Description
Handle Grip - Red (10/Bag)

**List
Price**
\$ 4.47

POLARIS IMPELLER, O-RING

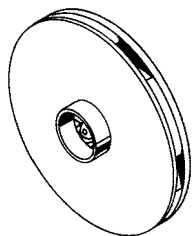

**Val-Pak
Part No.**
V50-116
V50-117

Description
PB-4 Booster Pump Impeller
Volute O-Ring (12/Bag)

**OEM
Part No.**
P-15

**List
Price**
\$ 22.65
\$ 1.83

PUMP & SKIMMER BASKETS

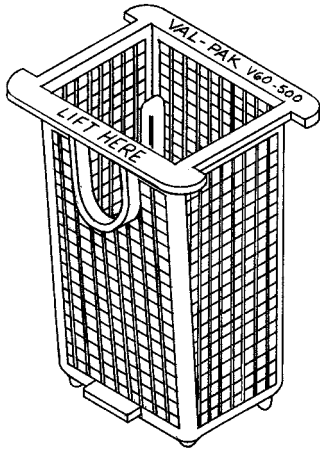

V60-500 (18/Box)
Hayward Super
Pump Basket
\$12.60

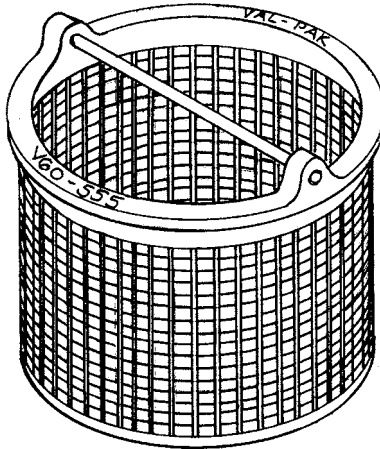

V60-555 (12/Box)
Hayward 1082
Skimmer Basket
\$20.91

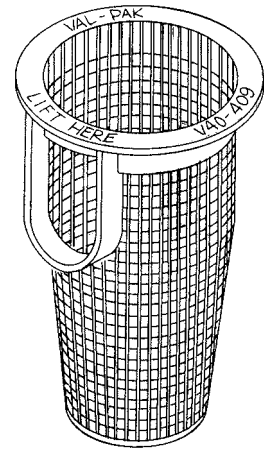

V40-409 (12/Box)
Dominator
Pump Basket
\$13.20

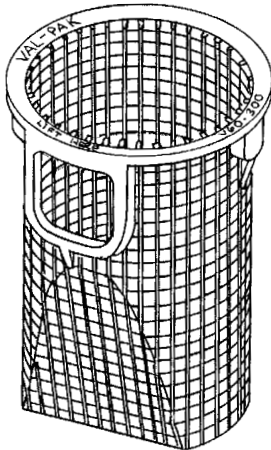

V60-300 (12/Box)
Hayward Super II
Pump Basket
\$12.30

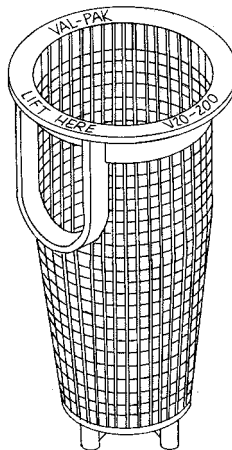

V20-200 (24/Box)
Whisper-Flo
Pump Basket
\$15.45

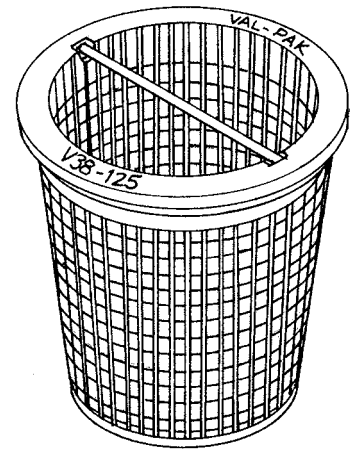

V38-125 (20/Box)
American Products
Tapered Skimmer Basket
\$23.43

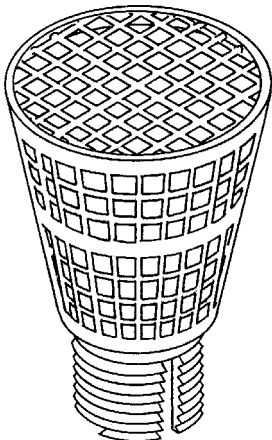

V50-120 (28/Box)
Val-Pak Inverted
Strainer Basket
\$22.47

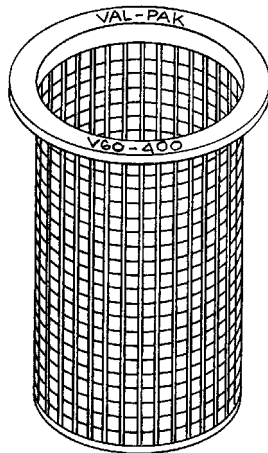

V60-400 (16/Box)
Hayward Standard
Cannister Basket
\$11.10

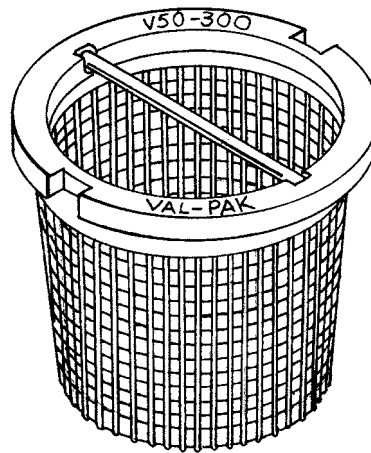

V50-300 (28/Box)
Waterway
Skimmer Basket
\$20.91

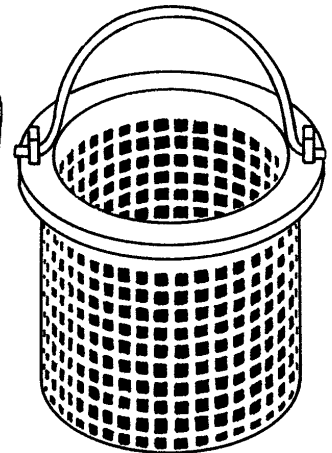

V65-101
WET Industries
6" Pump Basket
\$21.23

PUMP & SKIMMER BASKETS (Continued)

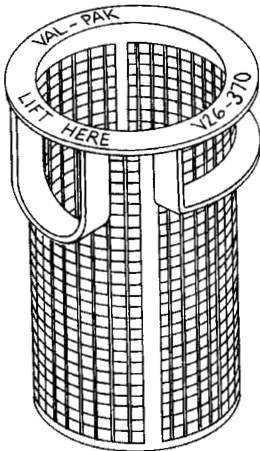

V26-370 (16/Box)
Max-E-Glas II & Max-E-Pro
Pump Basket
\$13.47

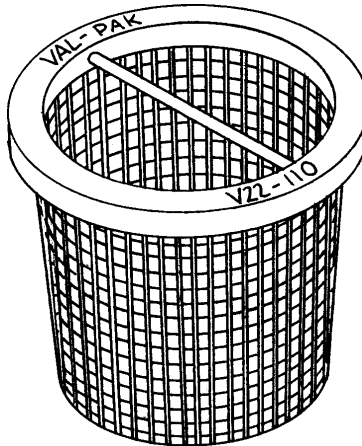

V22-110 (28/Box)
U3, Sta-Rite & Hayward
Skimmer Basket
\$20.91

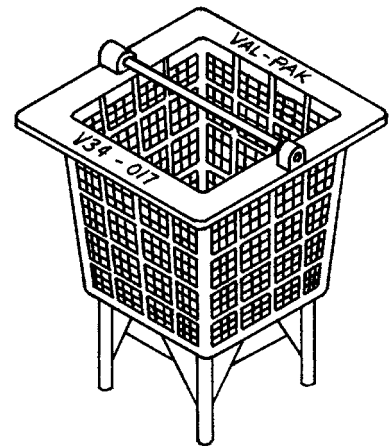

V34-017 (18/Box)
Anthony
Skimmer Basket
\$17.85

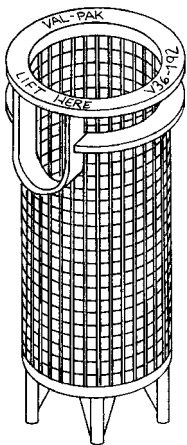

V36-192 (12/Box)
Challenger
Pump Basket
\$22.50

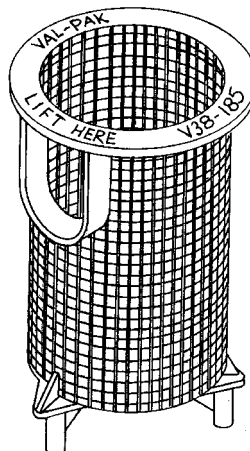

V38-185 (12/Box)
Ultra-Flow
Pump Basket
\$30.96

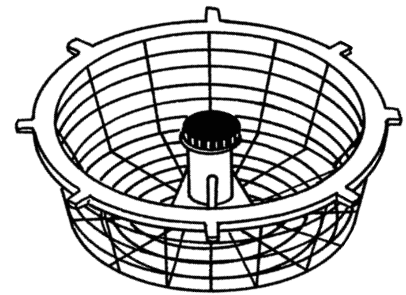

V28-600
Landon/Marlin
Skim Filter Basket
\$25.50

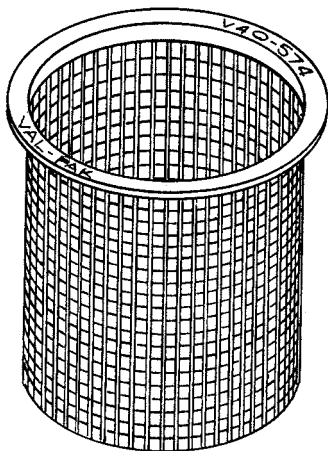

V40-574
Martin/Aqua-Flo/Premier
8" S.S. Pump Basket
\$142.50

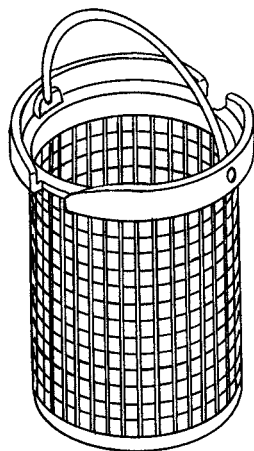

V40-465 (24/Box)
Martin/Aqua-Flo/Premier
5" Pump Basket
\$19.50

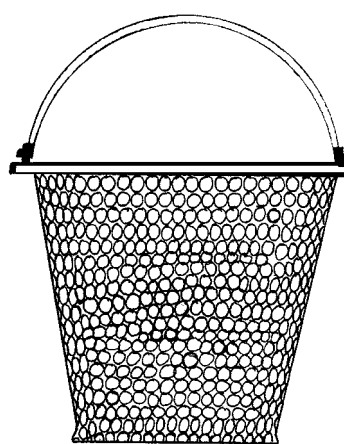

V20-312
Purex/Pentair
C-Series Basket
\$318.00

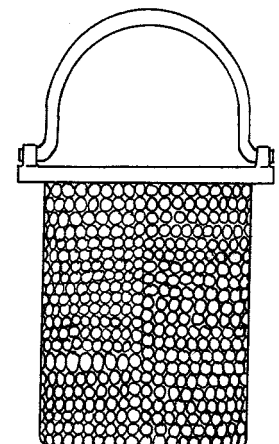

V40-466
Martin/Aqua-Flo/Premier
6" Pump Basket
\$21.75

O-RINGS

	Val-Pak Part Number	Description	Price
PUMP	V38-161	American Products Ultra-Flow Pump Lid O-Ring (Pre-94) (12/Bag)	\$3.43
	V38-164	American Products Ultra-Flow Pump Lid O-Ring (94-Present) (12/Bag)	\$3.43
	V34-012	Anthony Seal Plate O-Ring - AR Pump	\$11.57
	V34-013	Anthony Diffuser Seal O-Ring - AR Pump	\$16.99
	V40-117	Aqua-Flo 5" Pump Lid O-Ring (12/Bag)	\$2.83
	V60-301	Hayward Super II Pump Lid O-Ring (12/Bag)	\$2.55
	V50-117	Polaris Volute O-Ring (12/Bag)	\$1.83
	V20-389	Purex Whisperflo Pump Lid O-Ring N/S (12/Bag)	\$2.19
	V20-375	Purex A Series Seal Flange O-Ring (12/Bag)	\$1.56
	V20-309	Purex C Series Seal Flange O-Ring	\$3.61
	V20-308	Purex AH Series Pot Lid O-Ring (12/Bag)	\$2.62
	V20-310	Purex C Series Pot Lid O-Ring	\$11.32
	V26-366	Sta-Rite 6" Trap Cover O-Ring (12/Bag)	\$2.55
	V26-360	Sta-Rite Max-E-Glas/Dura-Glas 5" Trap Cover O-Ring (12/Bag)	\$2.55
	V26-365	Sta-Rite Max-E-Glas II/Max-E-Pro Trap Cover O-Ring (12/Bag)	\$2.69
	V26-368	Sta-Rite Diffuser O-Ring (12/Bag)	\$1.96
	V26-354	Sta-Rite Seal Plate O-Ring (50/Bag)	\$4.18
	V30-465	Swimrite 5" Brass Lid O-Ring (12/Bag)	\$2.55
BACKWASH VALVE	V38-102	American Products Piston O-Ring Set 1½" (25/Bag)	\$3.36
	V38-103	American Products Piston O-Ring Set 2" Brass Old Style (25/Bag)	\$3.36
	V38-121	American Products Piston O-Ring Set 2" Plastic New Style (25/Bag)	\$3.36
	V34-115	Anthony Piston O-Ring Set 1½" Brass (25/Bag)	\$3.36
	V34-120	Anthony Piston O-Ring Set 2" Brass (25/Bag)	\$3.36
	V34-141	Anthony Piston O-Ring Set 2" Plastic (25/Bag)	\$3.96
	V36-185	Pac-Fab Piston O-Ring Set, 2" Brass Old Style (25/Bag)	\$3.36
	V36-186	Pac-Fab Piston O-Ring Set, 2" Brass New Style (25/Bag)	\$3.36
	V26-339	Sta-Rite Piston O-Ring Set 1½" O/S (25/Bag)	\$3.36
	V26-340	Sta-Rite Piston O-Ring Set 1½" 3-Puck (25/Bag)	\$3.36
	V26-341	Sta-Rite Piston O-Ring Set 2" (25/Bag)	\$3.36
	V22-115	Swimquip Piston O-Ring Set 1½" (25/Bag)	\$3.36
	V22-116	Swimquip Piston O-Ring Set 2" (25/Bag)	\$3.36
	V22-121	Swimquip Piston O-Ring Set 2" Plastic (25/Bag)	\$4.00
	V30-422	Swimrite Piston O-Ring Set 1½" O/S N/S (25/Bag)	\$3.36
V30-423	Swimrite Piston O-Ring Set 2" (25/Bag)	\$3.36	
V60-100	Hayward Backwash Piston O-Ring Set (25/Bag)	\$3.36	
FILTER	V38-156	American Products Repl. Valve Stem O-Ring (100/Bag)	\$.42
	V34-154	Anthony Tank Lid O-Ring 18" (25/Bag)	\$13.32
	V34-139	Anthony Tank Lid O-Ring 20" (25/Bag)	\$15.66
	V34-154	Premier 18" Tank O-Ring (25/Bag)	\$13.32
	V31-486	Premier 12" Tank O-Ring	\$10.97
	V20-319	Purex Brass Rotor O-Ring Kit (25/Bag)	\$5.95
	V20-353	Purex Noryl Rotor O-Ring Kit (25/Bag)	\$4.85
	V20-365	Purex 2000 Series Red Line Tank O-Ring (25/Bag)	\$20.52
	V30-480	Swimrite Satellite 24" Tank O-Ring	\$25.66
ORTEGA VALVE	V20-331	Purex Ortega Valve O-Ring Set 1½" (25/Bag)	\$2.62
	V20-332	Purex Ortega Valve O-Ring Set 2" (25/Bag)	\$2.62
CHLORINE FEEDER	V60-101	Hayward CL200 & CL220 Viton Lid O-Ring (12/Bag)	\$15.99